



Oso WRP Process Conversion and Upgrades (An O&M Perspective)

January 27, 2023

Today's Objective

- **Review Background**
- **Project Goals**
- **Overview of Improvements by Treatment Unit**
- **How O&M Perspective guided the design**

Oso WRP Background

- Constructed in 1941
- 5 major plant upgrades since
- Largest WWTP in Corpus Christi
- Growing service area
- Current Capacities:
 - 16.2 MGD ADF
 - 98 MGD Peak 2hr
- Discharge Permit since 2013
 - 20 mg/L BOD
 - 20 mg/L TSS
 - 4 mg/L NH3 ←



Existing Process

- Contact stabilization
- Removes BOD efficiently but.....
 - Short SRT ➔ limited nitrification
 - Prohibited by TCEQ as stand-alone process for NH3 removal
- Breakpoint Chlorination added in 2013

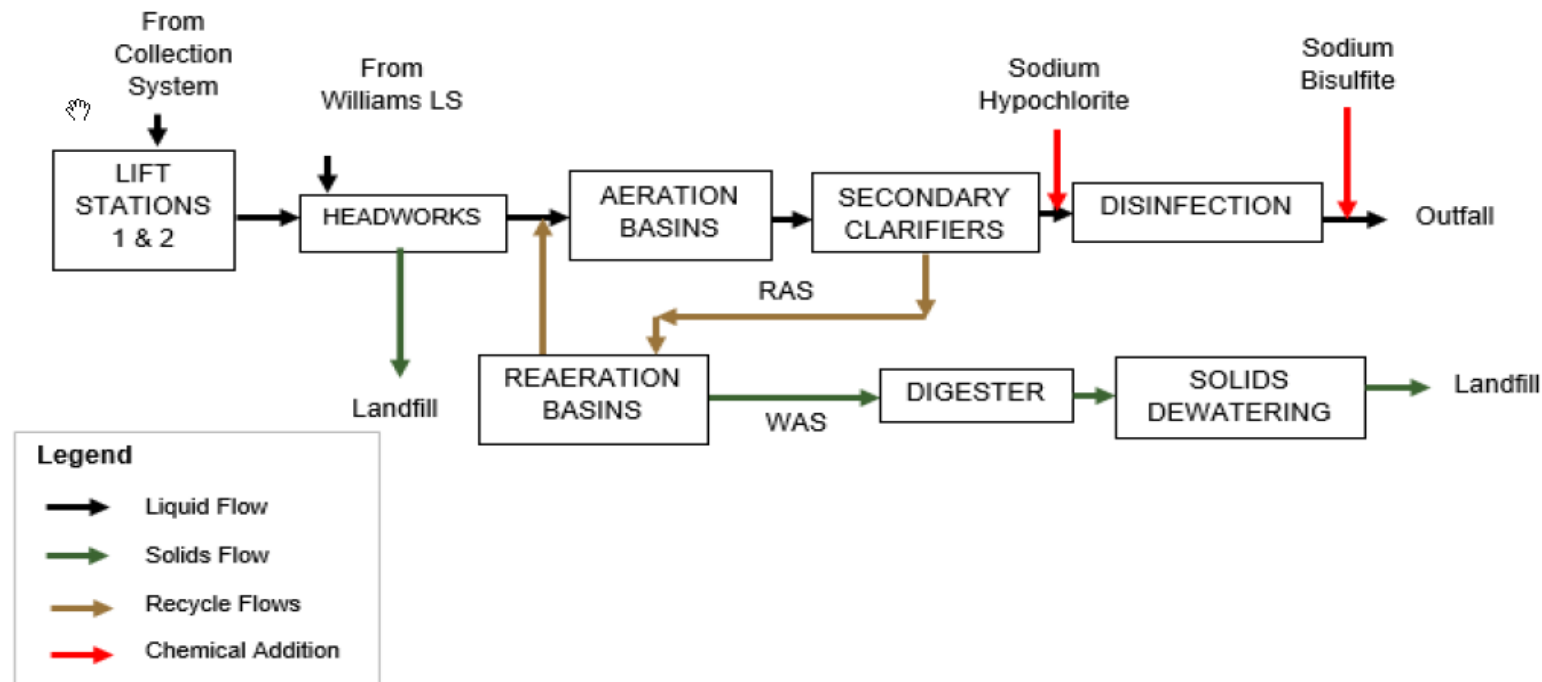

Issues with Existing Process

- Very limited nitrification capabilities
- Inefficient and aged air system
- O&M challenges:
 - Unable to perform AB O&M: ADF 12 MGD > 8.1 MGD/ea train
 - BPC requires significant staff attention & monitoring
 - High risk associated with de-chlorination
- O&M Costs - BPC chemicals and aeration electrical power

Project Goals

Goal	Why?
18 MGD capacity – 3 rd Train	Currently at 75% capacity and growing service area
Replace BPC system with BNR	Cost savings and reduced risk
Replace disinfection equipment	Exceeded design life and reduced capacity required
Replace aged and inefficient aeration equipment	Cost savings and reduced maintenance
Upgrade clarifier equipment	Reduce O&M efforts required to maintain service

Proposed Process

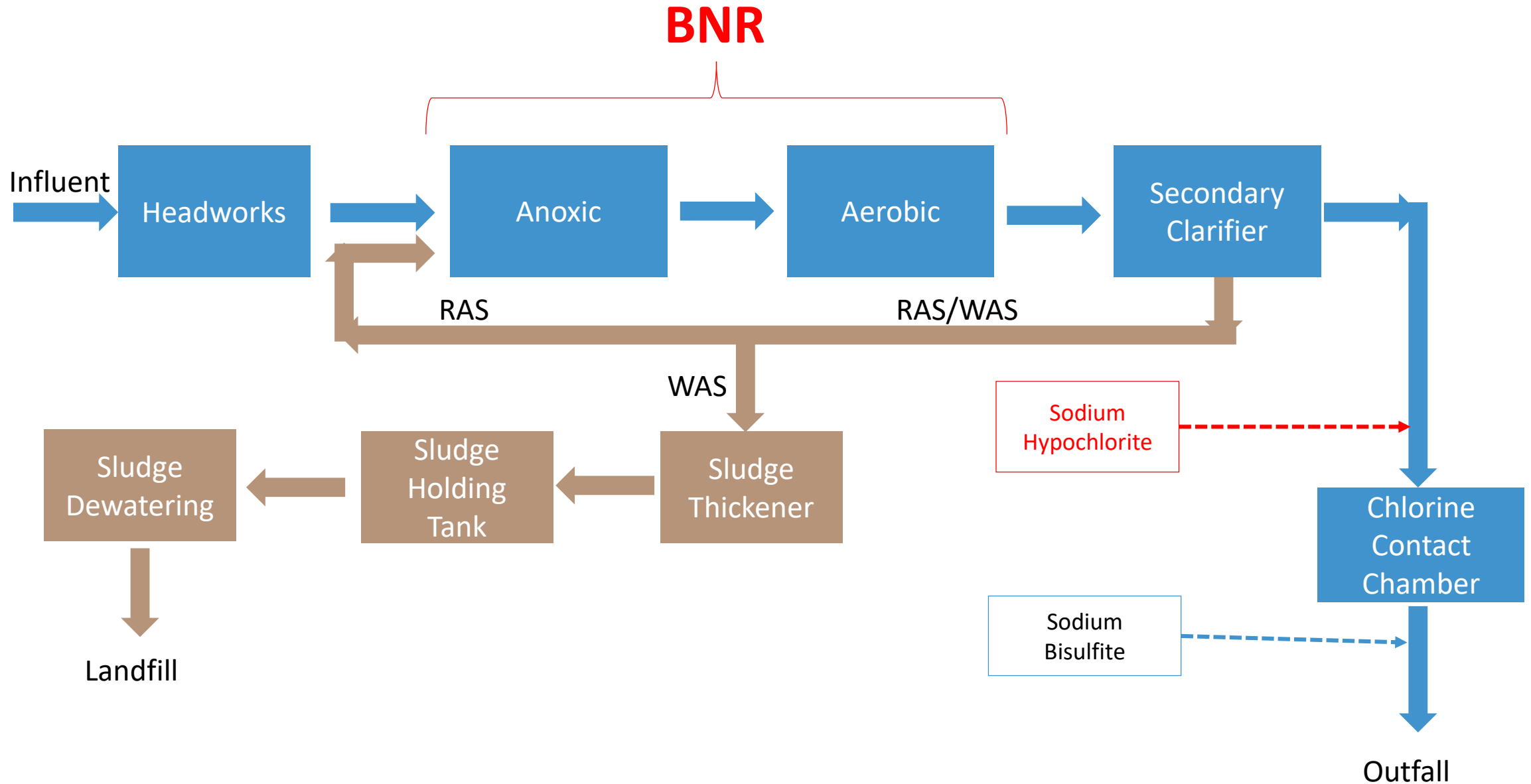

Key Improvements & O&M Considerations

Overall Site Layout

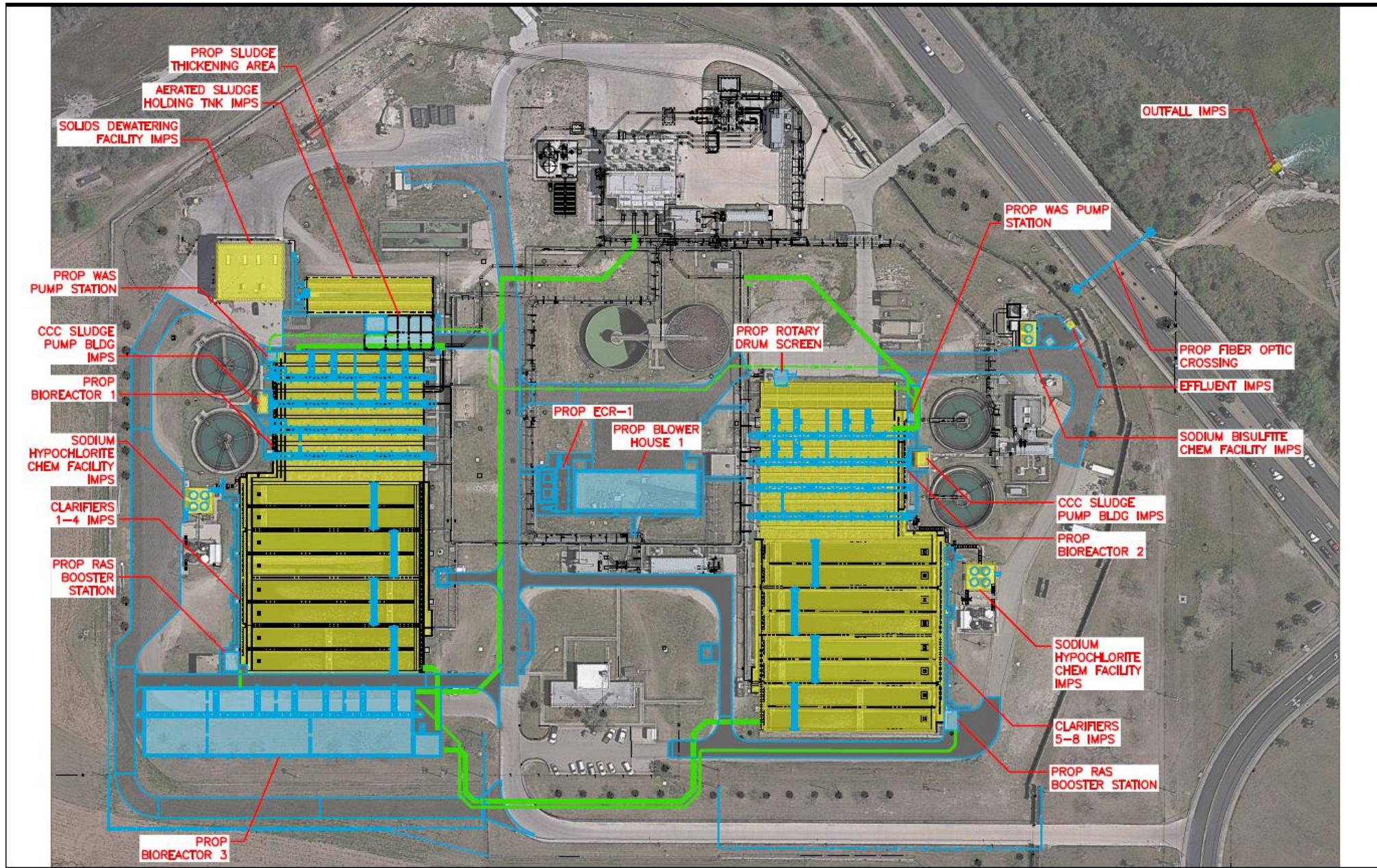

Bioreactors 1, 2 & 3

- Provide BNR and 18 MGD capacity
 - Retrofit E/W Aeration Basins → Bioreactors 1 & 2
 - New Bioreactor 3
 - Fine bubble diffusers
 - Hyperbolic mixers
 - IMLR pumps
- Access walkways with appurtenances
 - Hose bibs
 - Power outlets
 - Lighting



Bioreactors - O&M Considerations

- Strip diffusers
 - 1,600 strips <<<<< 11,000 discs
 - Apprx 40% more energy efficient
 - Varied diffuser density
- 3 Bioreactors
 - Allows for taking a train offline
- Air Piping Design
 - Meters air flow measurement & monitoring
 - Modulating FCV for operational flexibility
 - Isolation capability for maintenance & inspection
- DO sensors for process optimization
- SCADA
 - Operator feedback on system control and performance

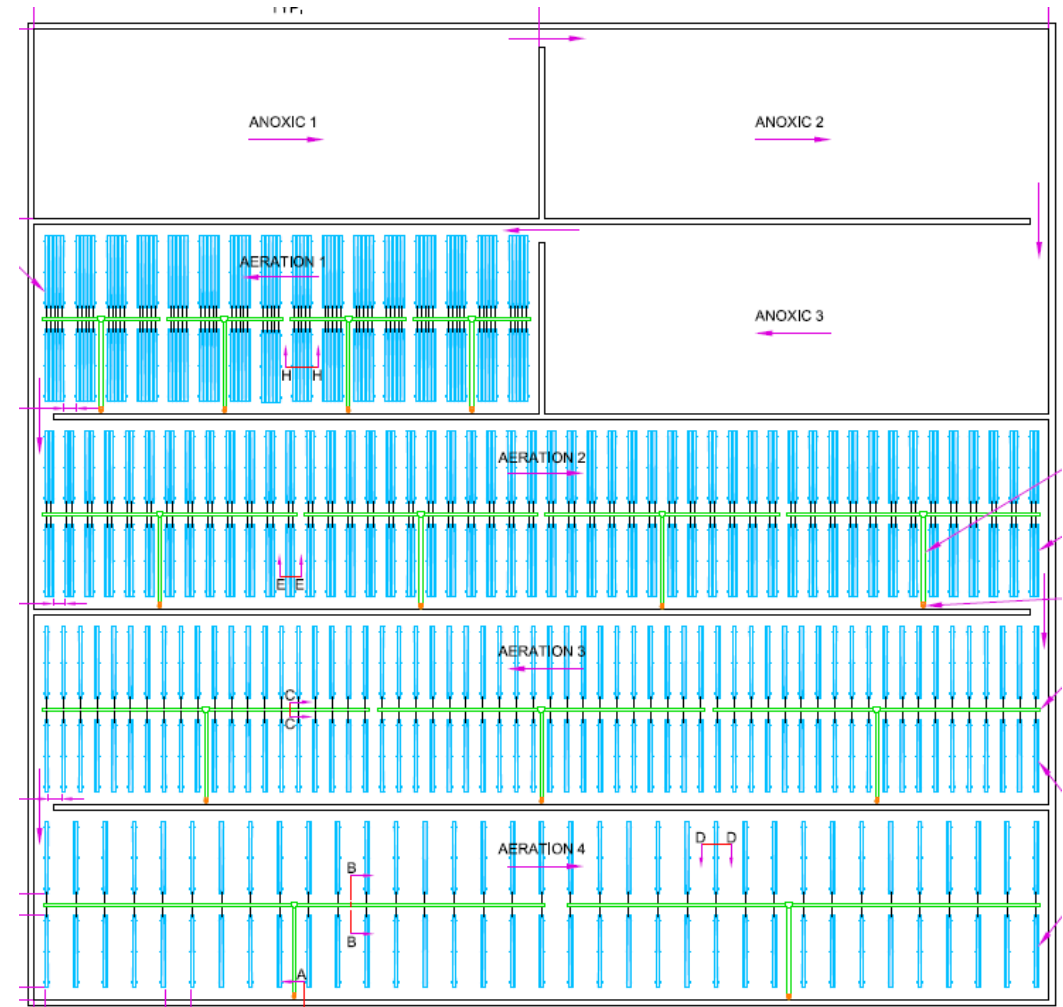

Bioreactors – Other O&M Considerations

- Provide draining capability for maintenance
- Walkway and equipment access
 - Provided 10ft wide walkways with removable handrails
 - Access to each mixer
- Lighting along walkway railings and equipment
- FRP grating to reduce corrosion
- Reduce tripping hazard with diffuser piping layout
- Adequate hose bib connections and racks for washdown and hose storage

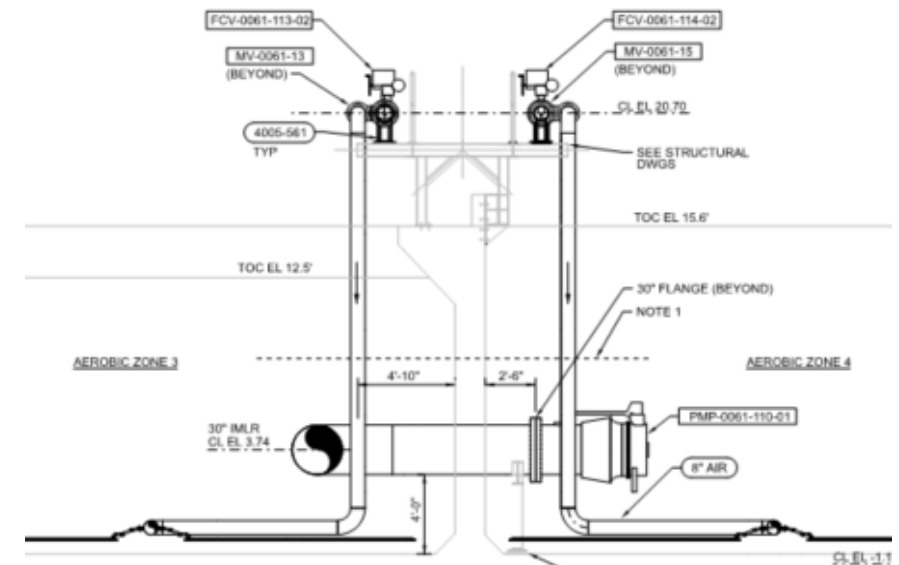
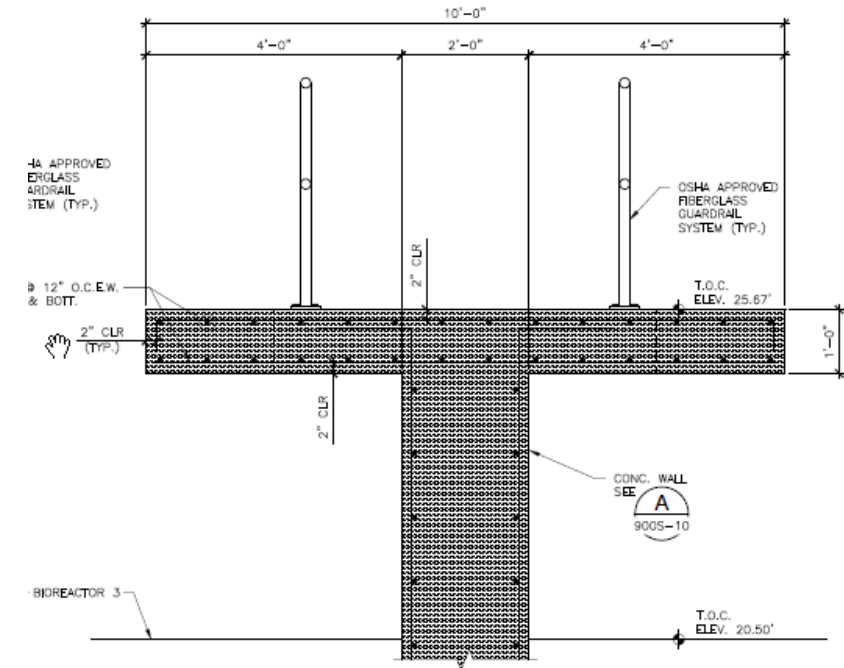

Blower House 1 - Overview

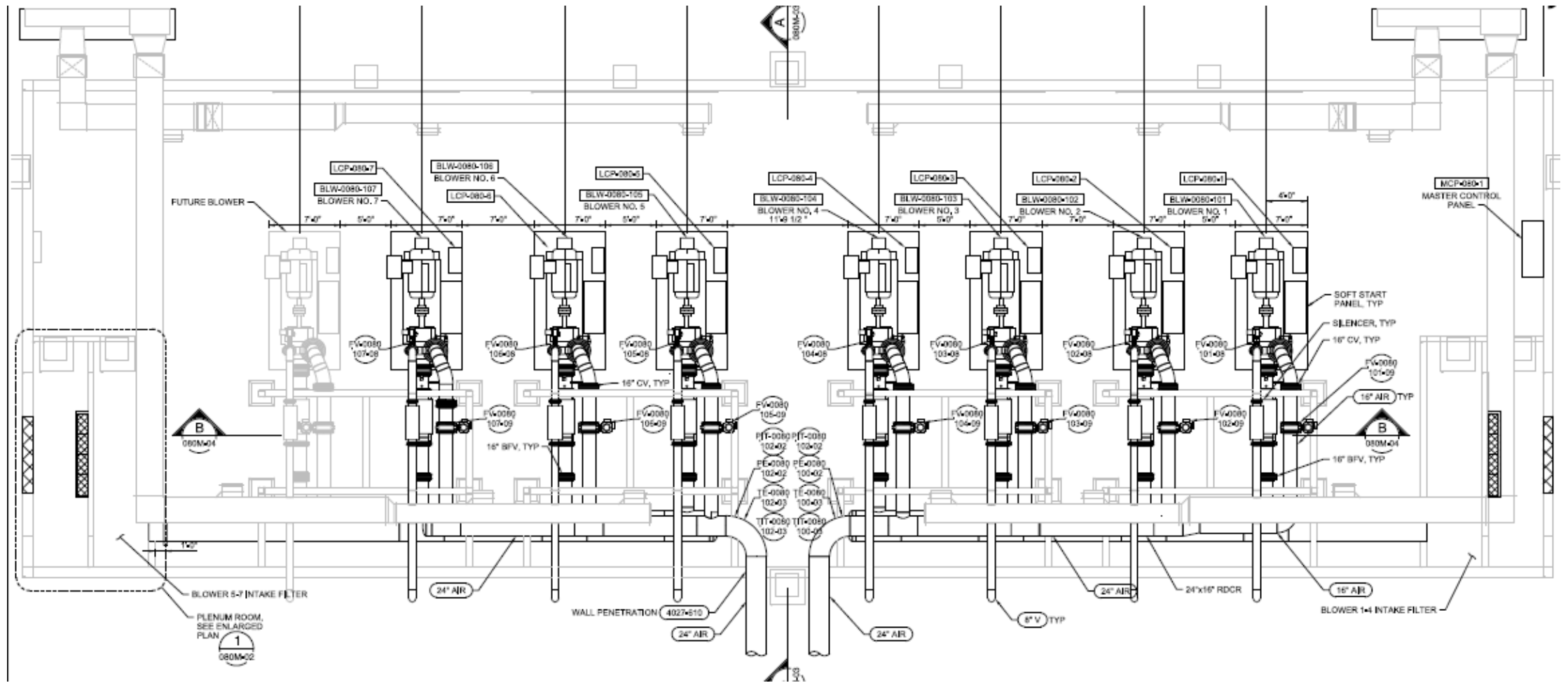

Blower House 1 – O&M Considerations

- Blower redundancy: 5 duty + 2 standby units
- Geared centrifugal type blowers
 - Operator familiarity (Allison WWTP)
 - Improved reliability
 - Proximity of service provider
 - Improved efficiency
- Filter rooms for simple filter replacement
- Separate air system for BRs (fine bubble) and sludge holding tanks (coarse bubble)



Blower House 1 - O&M Considerations

- Access-access-access
 - 7' blower spacing
 - 14' access corridor inside building
 - Large 18' W x 16' H rollup doors for crane truck access
 - Raised building ceiling to accommodate boom reach

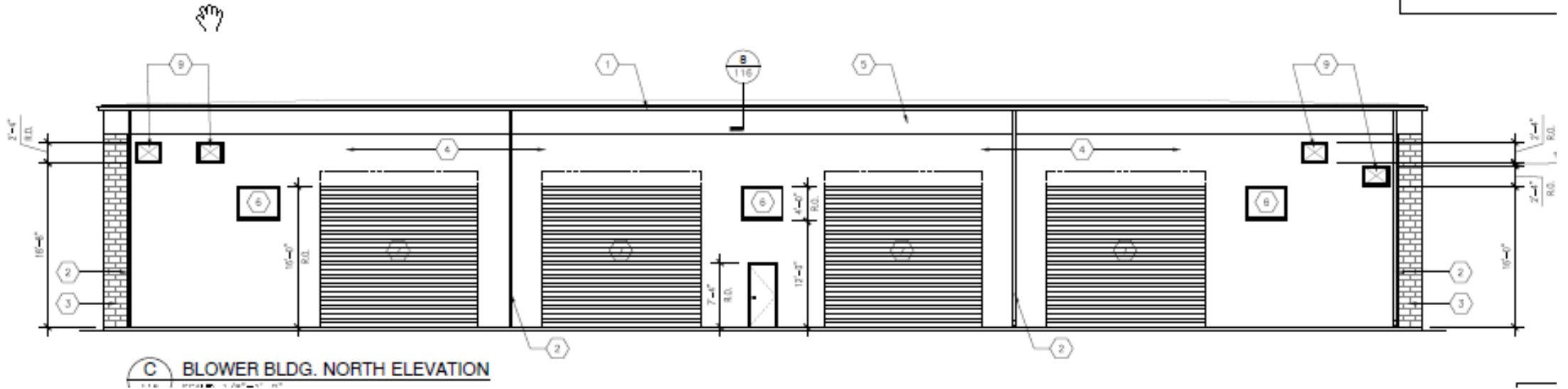

Secondary Clarifiers - Overview

- Traveling bridge replacement
- Scum system replacement

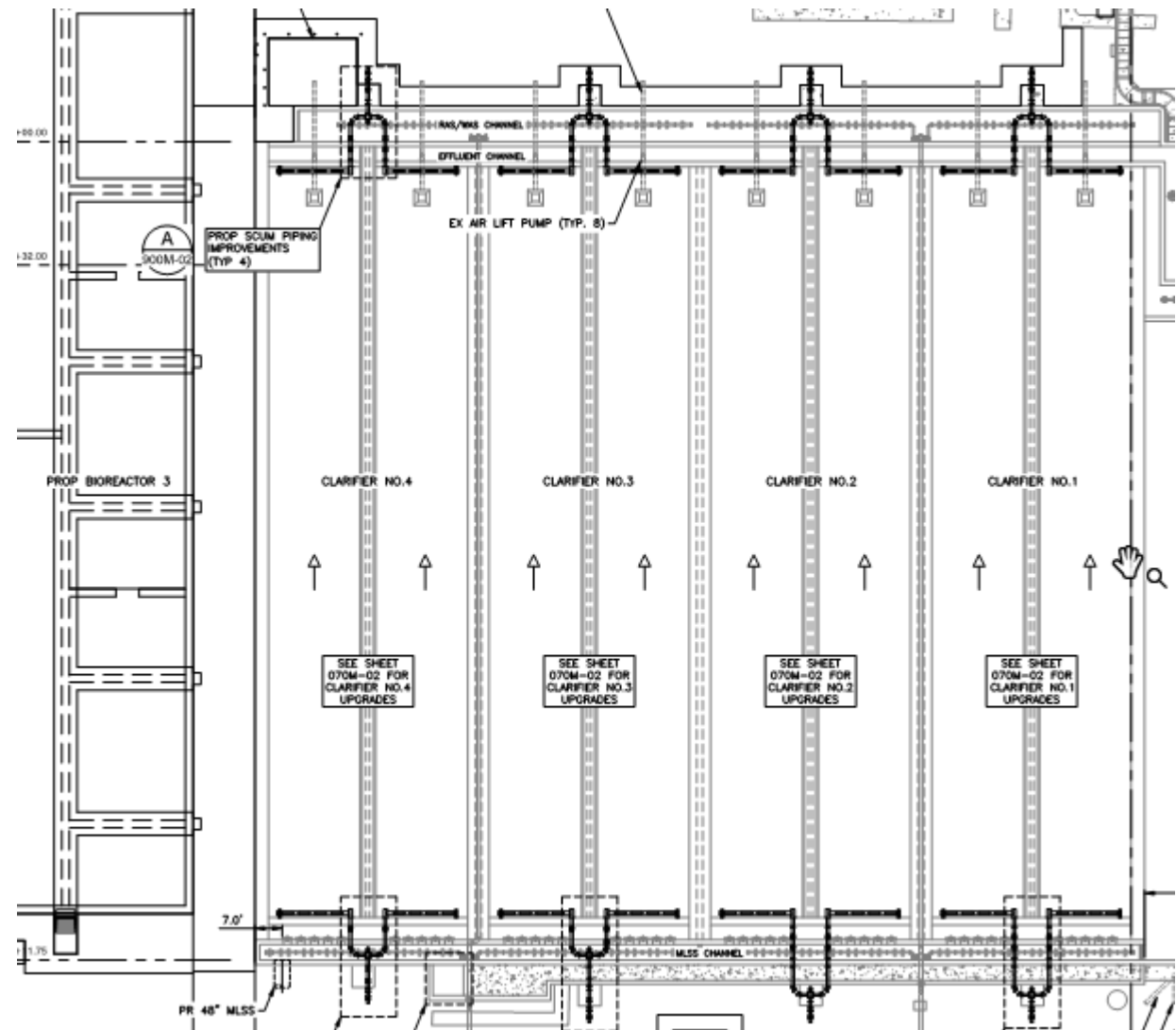

Secondary Clarifiers – O&M Considerations

- New traveling bridges with improved functionality
 - Line shaft drive with a cog wheel and track system to decrease alignment failures
 - Replace festoon cables with conductor bar power supply for decreased emergency failures (high winds)
 - Replace hydraulic drive system with electric driven system
- Replace automatic and spray skimming with manual scum skimming system
- RAS and WAS flow measuring capabilities for process control

Traveling Bridge Components



Traveling Bridge



Rail and Cog Track



Line Shaft Drive

Secondary Clarifiers – Other O&M Considerations

- Submerged Effluent Launder (SEL) System
 - Equipped with electrically actuated gates
 - Eliminates need for launder covers
 - Minimizes algae growth
 - Reduced flow short circuiting
- Repair clarifier drain system for maintenance
- Simplified slotted pipe skimmers equipped with a handwheel operator
- Provide redundant scum transfer pumps (1 duty + 1 standby)
- Redundant drum screen system

Disinfection Systems

- Significant Cl demand reductions with BNR
- Decommission existing BPC system
- FRP storage tanks for sodium hypochlorite and sodium bisulfite
 - Poor history of poly tank reliability
- New NaClO feed pumps: 2 duty, 2 standby per train
- New NaHSO₃ feed pumps: 1 duty, 1 standby

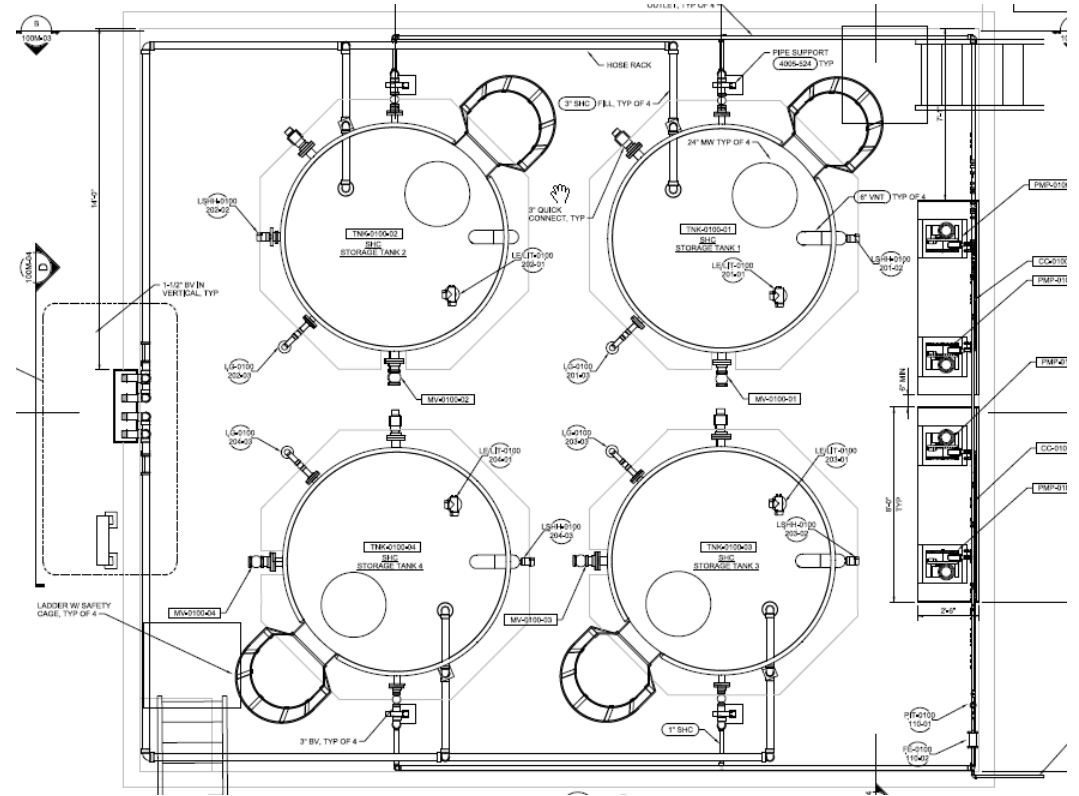

Current vs Proposed Disinfection Systems

Parameter	Cl ₂ Dose (mg/L)	Free Cl ₂ Residual (mg/L)	Cost (\$/year)
Current Disinfection System - BPC	13 - 110	1.5	\$1.9M
Proposed Disinfection System with BNR	6.0	1.5	\$0.2M
Approximate Savings per Year			\$1.7M

2019 with Existing System

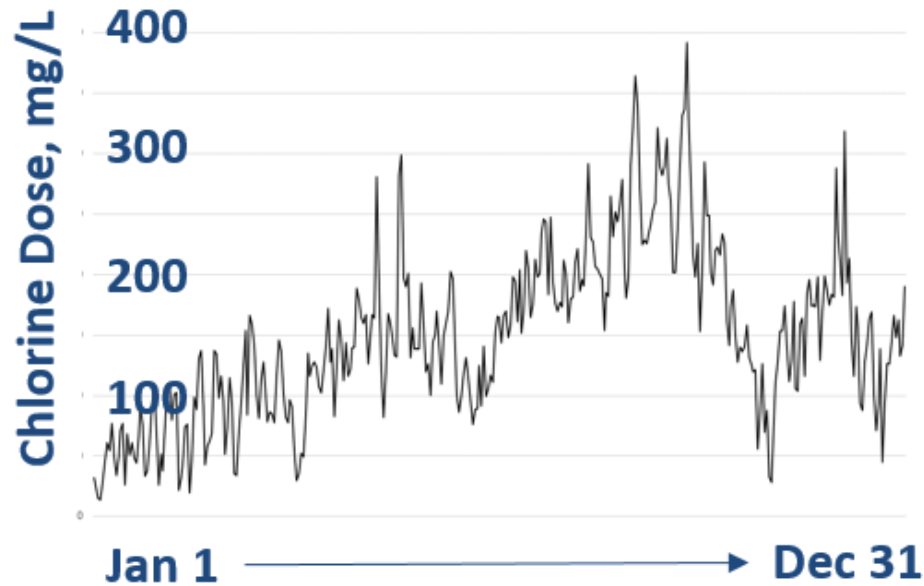

2019 with Process Upgrades

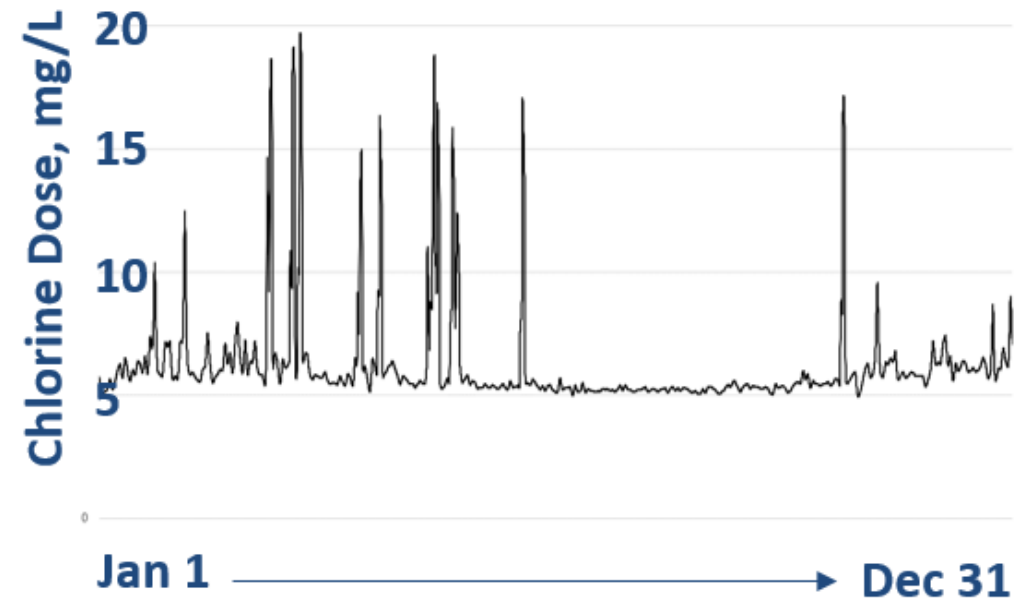

Solids Thickening System – O&M Considerations

- 3 Units: 2 Duty + 1 Standby
 - Slot for future unit
- Operates automatically with WAS Pumps
- Piping configuration allows for emergency WAS storage
- Pressure sustaining valve at ASHT1 for operational flexibility
- Unmanned operation: 24/7
- Forklift access to polymer totes
- Maintenance truck access to thickeners

Sludge Thickening Layout

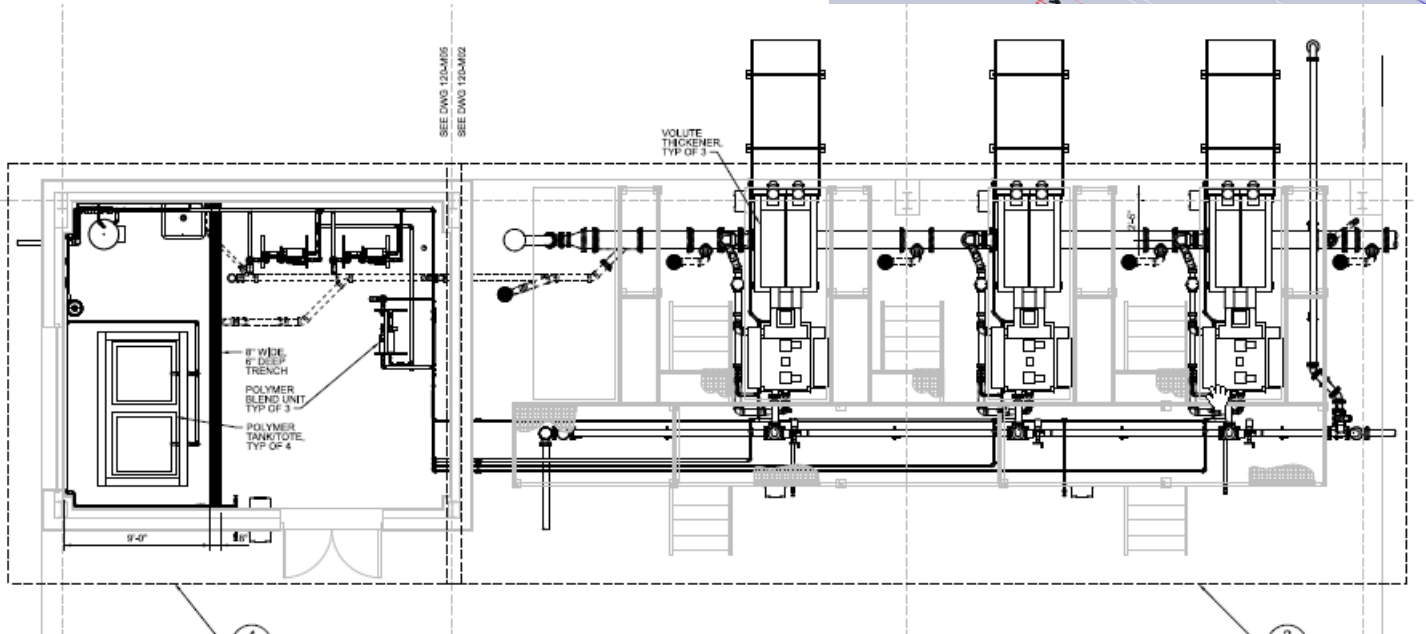
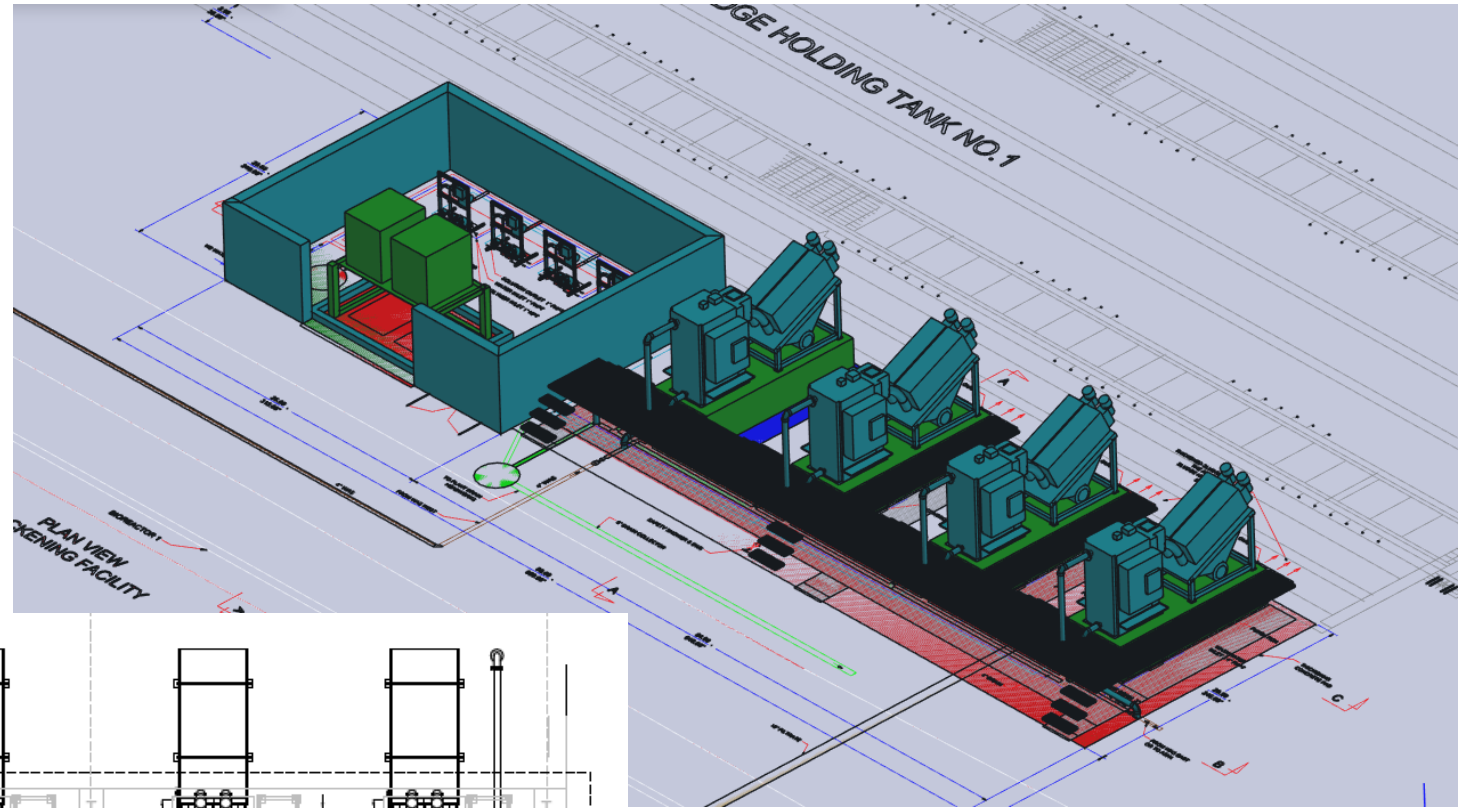

Solids Dewatering System – O&M Considerations

- 3 Units: 2 Duty + 1 Standby
 - Slot for future unit
- Piping arrangement eliminates single pt failure (TWAS to any unit)
- Decreased operating time required
 - 2 Unit Operation (Design): 11.2 hrs/day, 5 days/week operation
 - 3 Unit Operation (Emergency): 7.5 hrs/day, 5 days/week operation

Solids Dewatering Layout

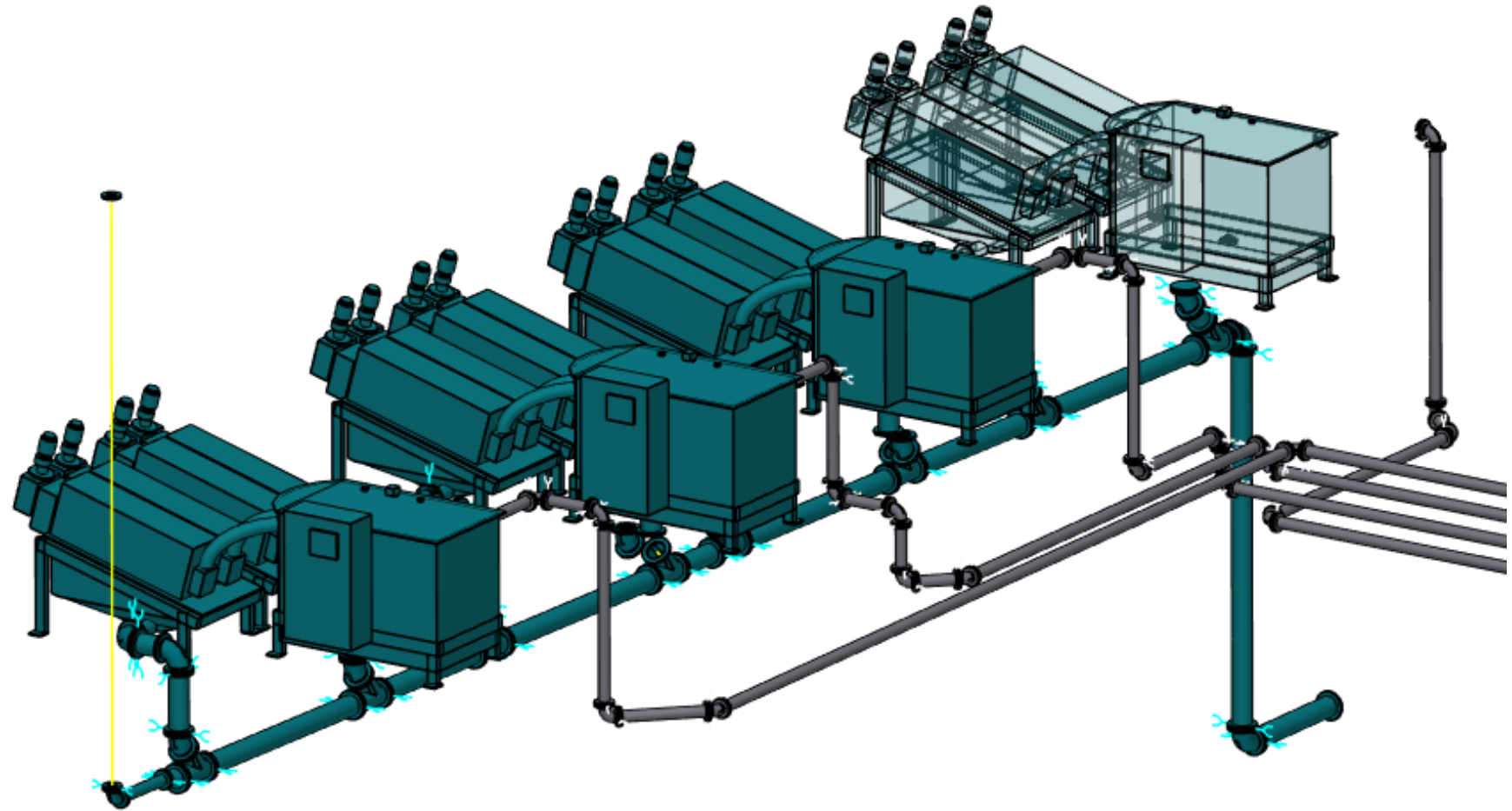

Thanks To Our Partners



City of Corpus Christi Utilities

Daniel Deng

Earl Richardson

Freddy DeLeon

Sandra Gomez

JACOBS®

Questions?



Additional Slides

28



ARDURRA

COLLABORATE. INNOVATE. CREATE.



TPDES Permit

Current Permit

- Issued on April 29, 2011
- Permit renewal application pending (submitted in December 2013)
- Revised Blind Oso Bay DO standards - Adopted by TCEQ – Feb 7, 2018
- No more hurdles for renewing/amending Oso WRP TPDES permit.

Parameter	Unit	30-day Avg.	7-day Avg.	Daily Max.
CBOD	mg/L	20	30	45
TSS	mg/L	20	30	45
Ammonia-Nitrogen	mg/L	4.0	6.0	10.0
Chlorine Residual	mg/L	N/A	N/A	0.1
Minimum DO	mg/L	5.0	5.0	5.0
pH	standard units	6.0 to 9.0	6.0 to 9.0	6.0 to 9.0
Enterococci	(CFU/100 ml)	35	N/A	89

Project Driver

■ Anticipated Permit Limits and Schedule

Proposed Phase	Flow (MGD)	CBOD (mg/L)	TSS (mg/L)	NH3 (mg/L)	DO (mg/L)
Interim Phase 1	16.2	20	20	4	5
Interim Phase 2	16.2	7	15	2	6
Interim Phase 3	18	7	15	2	6
Final	24	7	15	2	6

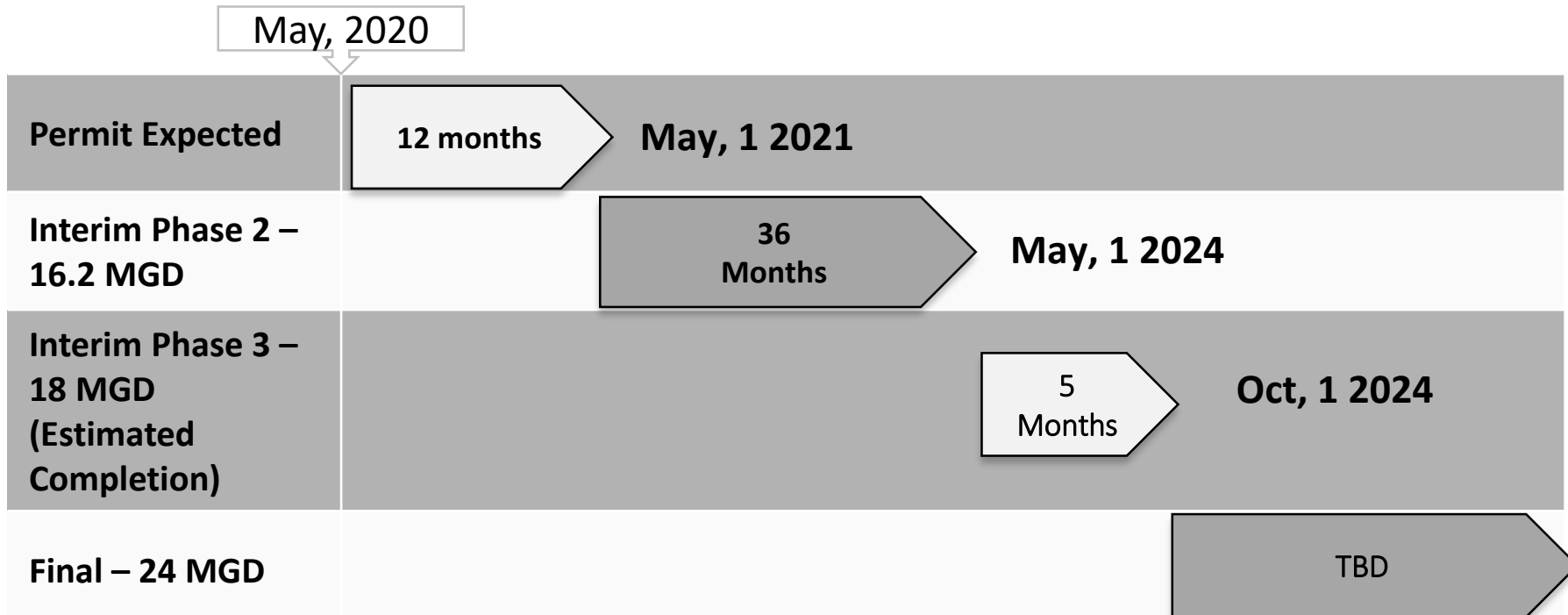

Design Criteria

Design Flows and Loadings

Flow Parameter	Value
Historical Average Flow (MGD)	12
Standard Deviation of Daily Flows (MGD)	2.5
Average Flow + 1 Standard Deviation (MGD)	14.5
Design Average Flow for Phase 2 Upgrade (MGD)	18
Design Peak Flow for Phase 2 Upgrade (MGD)	98

Parameter	Design		Data, lbs/d (date)
Minimum Daily Flow (MGD)	9.7		-
Average Daily Flow (MGD)	18		-
Peak 2-Hr Flow (MGD)	98		-
BOD (MM lbs/d, mg/L@ ADF)	39,800	265	31,200 (Mar 2015)
TSS (MM lbs/d, mg/L@ ADF)	39,000	260	30,000 (May 2019)
TN (MM lbs/d, mg/L@ ADF)	8,400	56	5,500 (est.)
NH ₃ (MM lbs/d, mg/L@ ADF)	5,600	37	3,660 (Dec 2019)
Alkalinity (as CaCO ₃) (mg/L)	300		-
Min Mixed Liquor Temperature (°C)	18		-
Max Mixed Liquor Temperature (°C)	27		-

Bioreactors 1 & 2 - Basis of Design

Zone Description	Sidewater Depth	Zone Width	Zone Length	Zone Volume	Organic Loading	Organic Loading	Aerobic SRT	MLSS
-	ft	ft	ft	MG	lbs BOD/d	lbs BOD/d/1000cf	days	mg/L
Anoxic Zone 1	15.7	30.0	80.0	0.28	-	-	-	3,900
Anoxic Zone 2		30.0	80.0	0.28				
Anoxic Zone 3		30.0	80.0	0.28				
Aerobic Zone 1		30.0	80.0	0.28				
Aerobic Zone 2		30.0	160.0	0.56				
Aerobic Zone 3		30.0	160.0	0.56				
Aerobic Zone 4		30.0	160.0	0.56				
Single Bioreactor	15.7	150.0	160.0	2.82	13,259	35.2	5.0	3,900

Bioreactor 3 - Basis of Design

Zone Description	Sidewater Depth	Zone Width	Zone Length	Zone Volume	Organic Loading	Organic Loading	Aerobic SRT	MLSS
-	ft	ft	ft	MG	lbs BOD/d	lbs BOD/d/1000cf	days	mg/L
Anoxic Zone 1	15.7	30.0	80.0	0.28	-	-	-	3,900
Anoxic Zone 2		30.0	80.0	0.28				
Anoxic Zone 3		30.0	80.0	0.28				
Aerobic Zone 1		77.0	73.0	0.66				
Aerobic Zone 2		46.5	121.0	0.66				
Aerobic Zone 3		46.5	121.0	0.66				
Total	15.7	43.4	555.0	2.82	13,259	35.1	5.0	3,900

Bioreactors - O&M Considerations

Ovivo USA LLC:
1600# Strip Diffusers

Sanitaire, Aquarius:
11000# Disc Diffusers

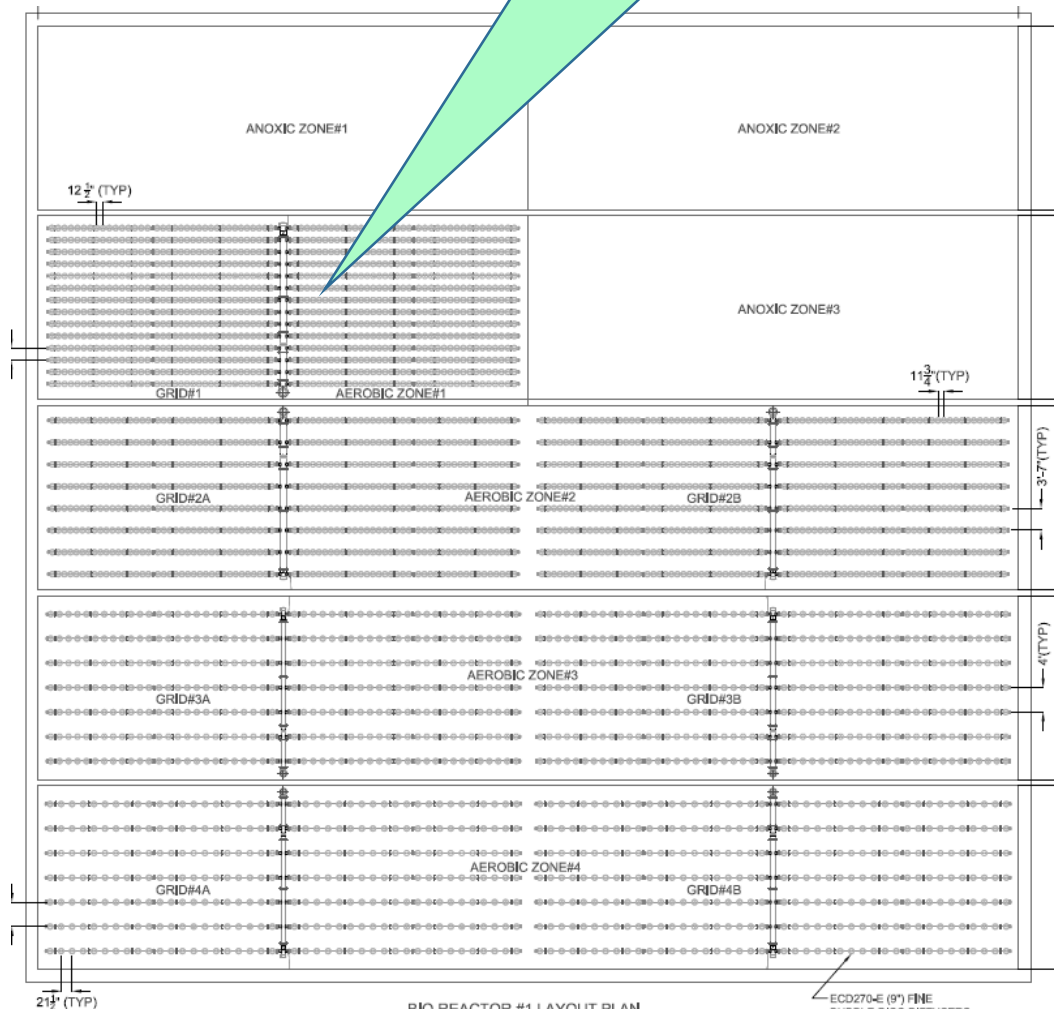
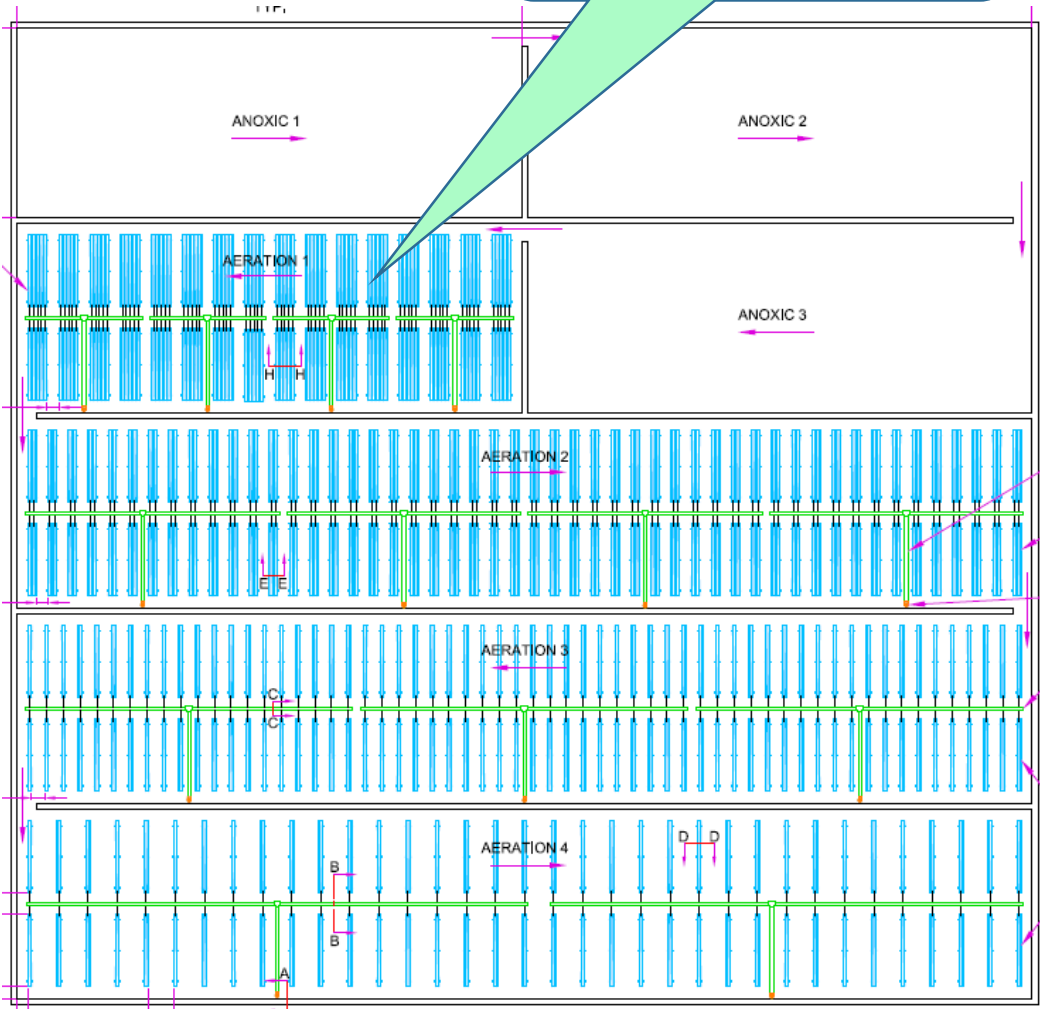

BIO REACTOR #1 LAYOUT PLAN
 ONE (1) SHOWN TWO (2) REQUIRED
 ECD270-E (9") FINE BUBBLE DISC DIFFUSERS



Process Modeling

Process Modeling & Calibration

■ Biowin Modeling Steps

— Calibration

— Model Scenarios

- *Steady-state maximum month load*

--- Effluent quality, Existing and New AB Reconfigurations/Sizing

- *Dynamic 1-year influent itinerary*

---- Year 2015 wet and high loading event on effluent Nitrate and TN

- *Dynamic 4-day 98 MGD peak flow event*

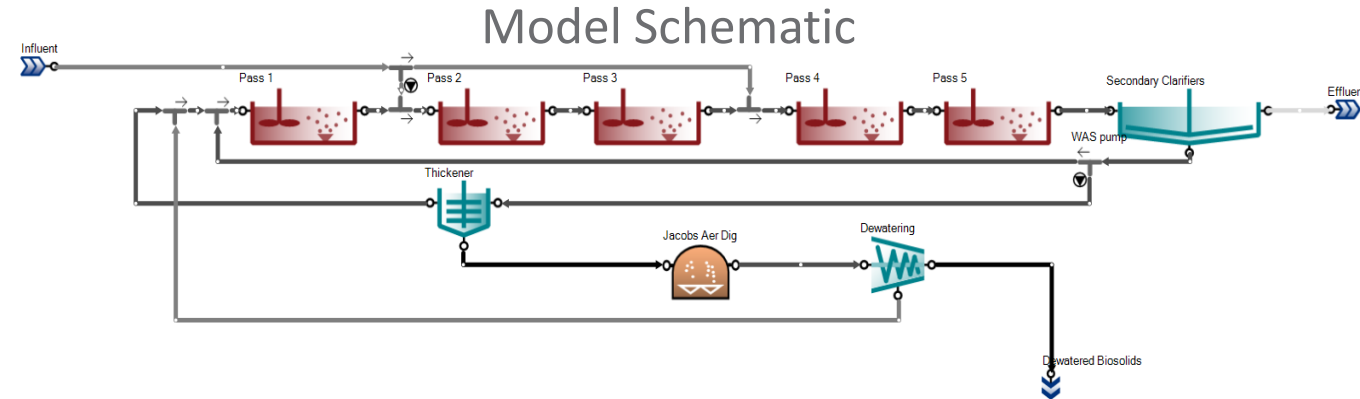

Calibration Results

Parameter	Model	2019 Data
MLSS, mg/L	3400	3400
MLVSS, mg/L	2500	2630
Dewatered Biosolids, lbs/d	16,500	15,900
Effluent TSS, mg/L	5	9
Effluent BOD ₅ , mg/L	2	7
Effluent NH ₃ , mg/L	10	10

- **GOOD CALIBRATION OF SOLIDS BALANCE**
- **EFFLUENT AMMONIA CALIBRATION WITH NO STEP FEED AND AERATION BASIN DO <1 MG/L**

Process Modeling & Calibration

Process Inputs:
Wastewater Characteristics
Loadings Dynamic Patterns

Process Model Variables:
Biological Reactions
Physical/Chemical

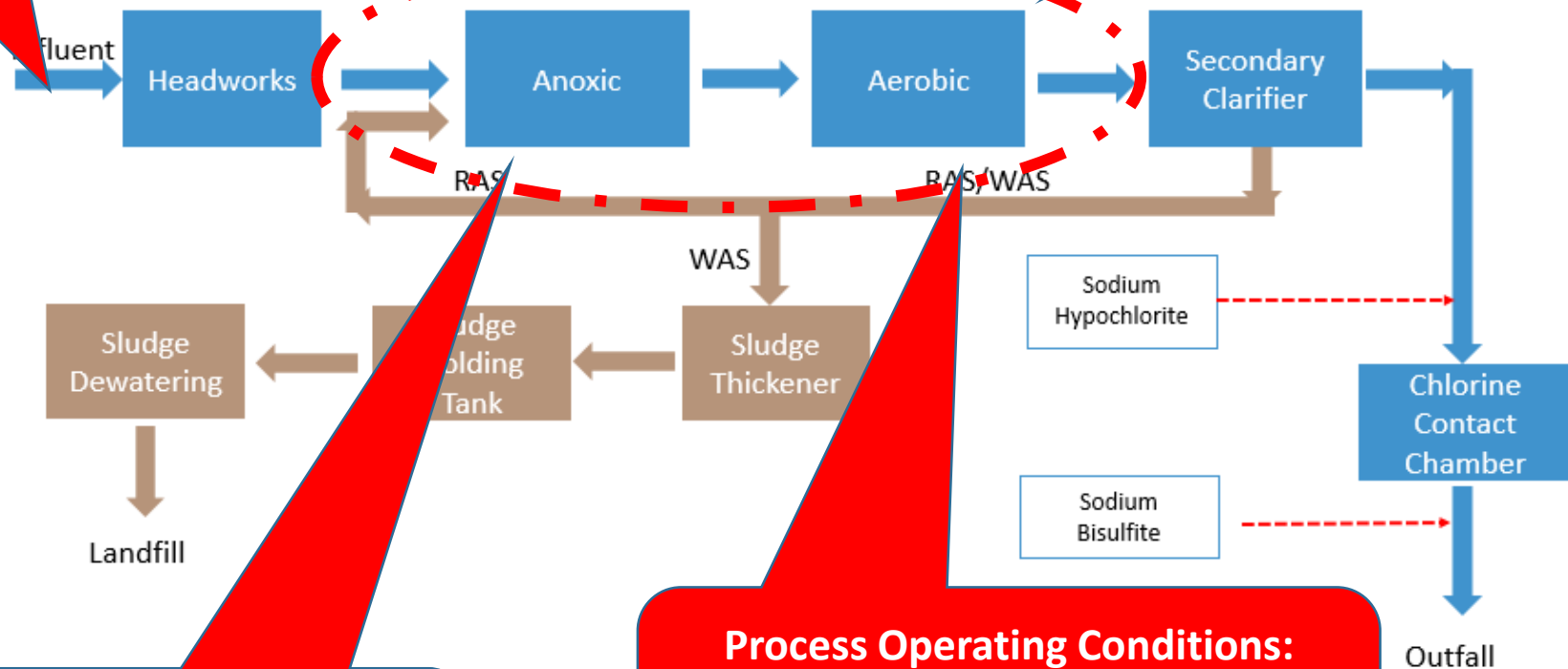

Process Configurations:
Flow Routing
Unit Sizes – Modify BR1&2, Size BR 3, MLSS Conc
Reactor Staging
Recycle Streams -

Process Operating Conditions:
Recycle Rates - RAS, WAS & IMLR
Aeration requirements
Effluent quality at MM and PH flows
DO Control Setpoints

Maximum Month (18 MGD) Model Results

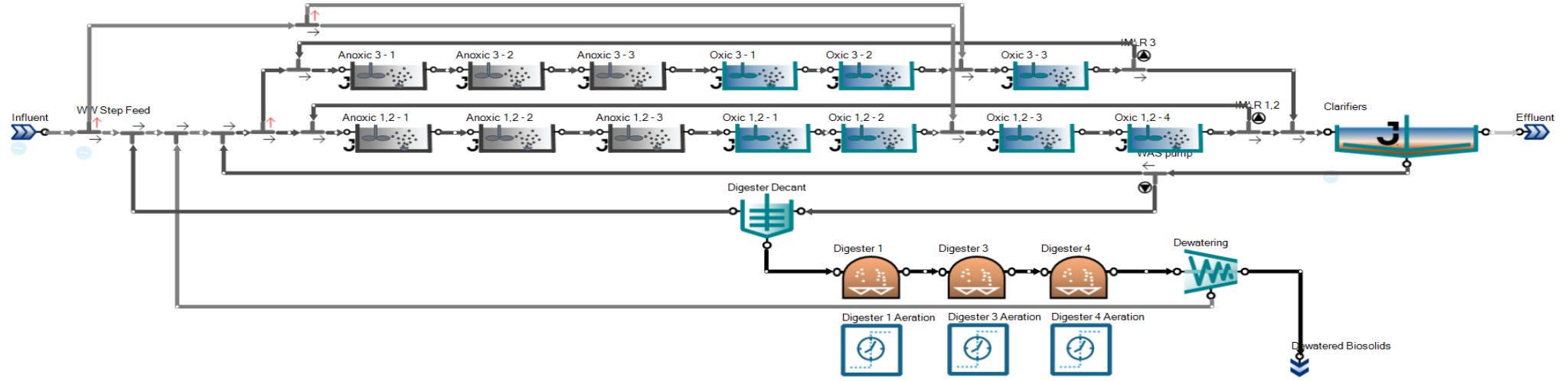

Parameter	Input/Result
Aerobic SRT, d	5
TCEQ Required SRT	4.76
MLSS, mg/L	3700
Airflow, SCFM	24,500
Clarifier Solids Loading Rate, lbs/d/ft ²	13
Clarifier Surface Overflow Rate (SOR) gpd/ft ²	240
Maximum SOR Allowed by TCEQ, Table F.9.	400

One-Year Dynamic Model Results

2015 Data set used due to having several wet-weather and high loading peaks

One-Year Dynamic Model Results – Effluent Nitrogen

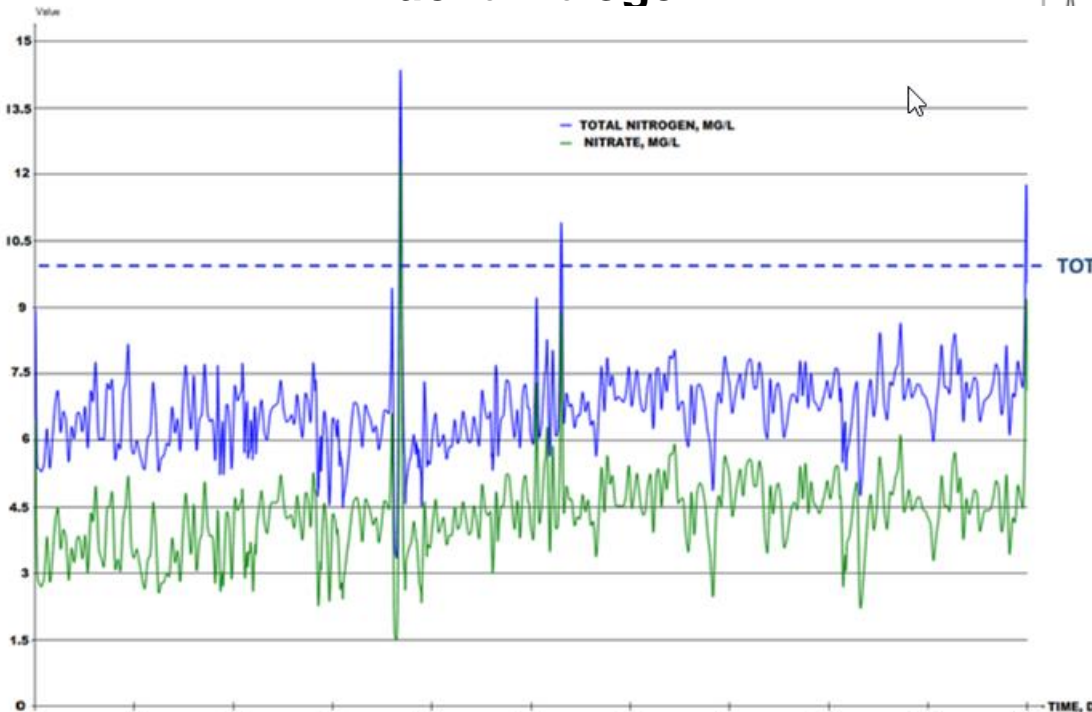

One-Year Dynamic Model Effluent Quality vs. Flow

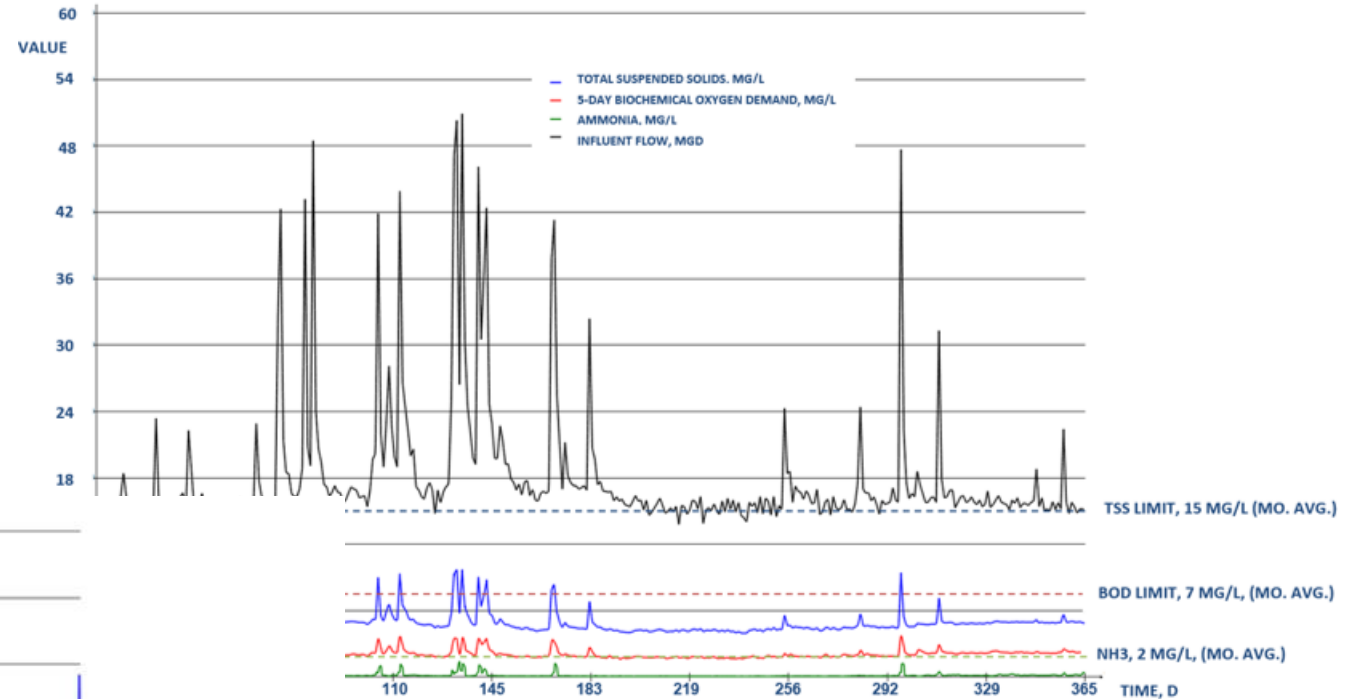

Significantly less NaClO required after BNR upgrades

- Free Chlorine Residual Control
 - BPC = chemical treatment to remove all NH3
 - Free Chlorine Residual System = biologically remove NH3 before chemical treatment

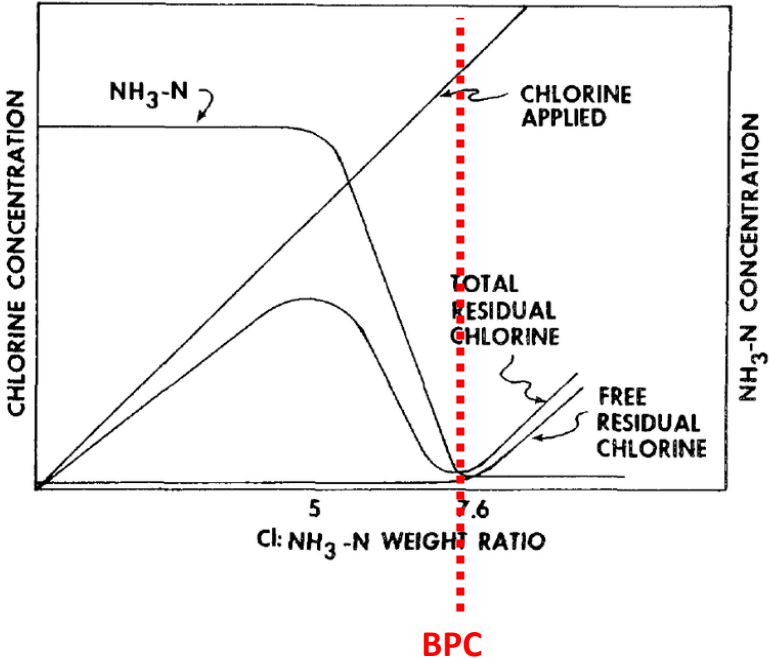

SODIUM HYPOCHLORITE (NaClO)- PROPOSED SYSTEM			
Parameter	Value	Unit	Notes
NaOCl Doses			
Cl2:NH3 Ratio	10:1		
Chlorine Demand	3	mg/L	Max demand in addition to ammonia demand
Target Free Chlorine Residual	1.5	mg/L	Will meet the enterococci limits at all flows
Avg Dose			
Avg Effluent NH3	0.2	mg/L	From Process Modeling
Avg Design NaClO Dose	6.5	mg/L	
Min Dose			
Avg Effluent NH3	0.2	mg/L	From Process Modeling
Min Design NaClO Dose per TCEQ	6	mg/L	TCEQ Table K.1
Chem Feed Pumps Max Dose			
Cl:NH3 Ratio	7:1		Dilute influent
Max Effluent NH3	1.5	mg/L	From Processing Modeling
Chlorine Demand	1	mg/L	Demand of dilute influent

Significantly less NaClO required after BNR upgrades

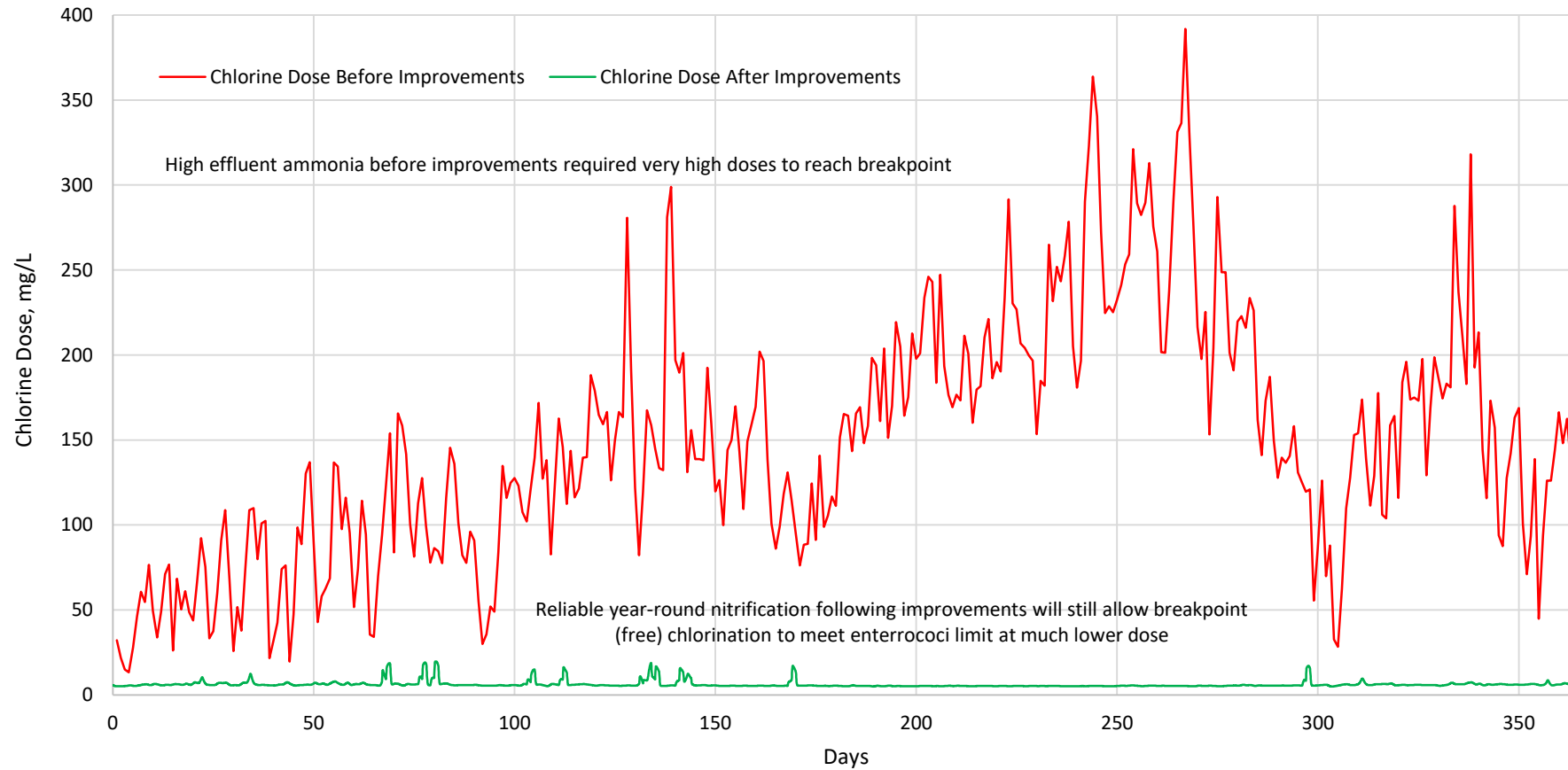

Key Improvements per Treatment Unit

Bioreactors 1 & 2 – Diffusers Layout

Parameter	Value	Units
Type	Fine Bubble, EPDM Disc	–
Manufacturer	Sanitaire, SSI, Aquarius	–
Discs per Train	≈ 3,400	#
Disc Diameter	9	inches



Bioreactor 3 – Fine Bubble Diffusers Layout

Parameter	Value	Units
Type	Fine Bubble, EPDM Disc	—
Manufacturer	Sanitaire, SSI, Aquarius	—
Discs per Train	≈ 3,400	#
Disc Diameter	9	inches

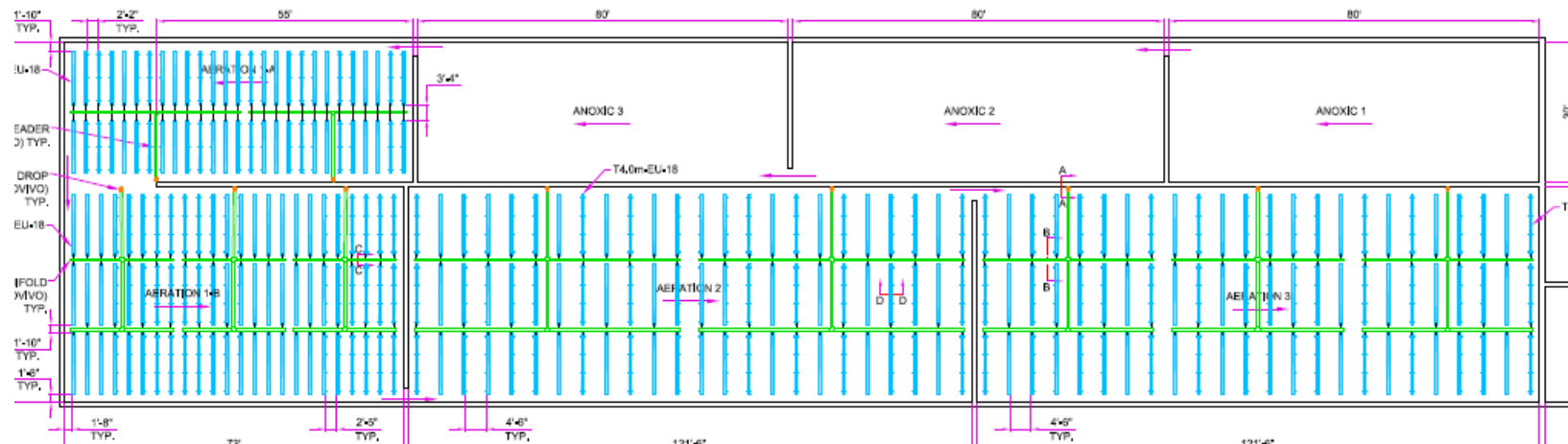

Bioreactors - Mixers

Design Criteria

Parameter	Value	Units
Type	Hyperbolic	—
Manufacturer	Invent	—
Mixers per Anoxic Zone	2	#
Diameter	98.4	inches
Power Consumption (per mixer)	1.7	hp

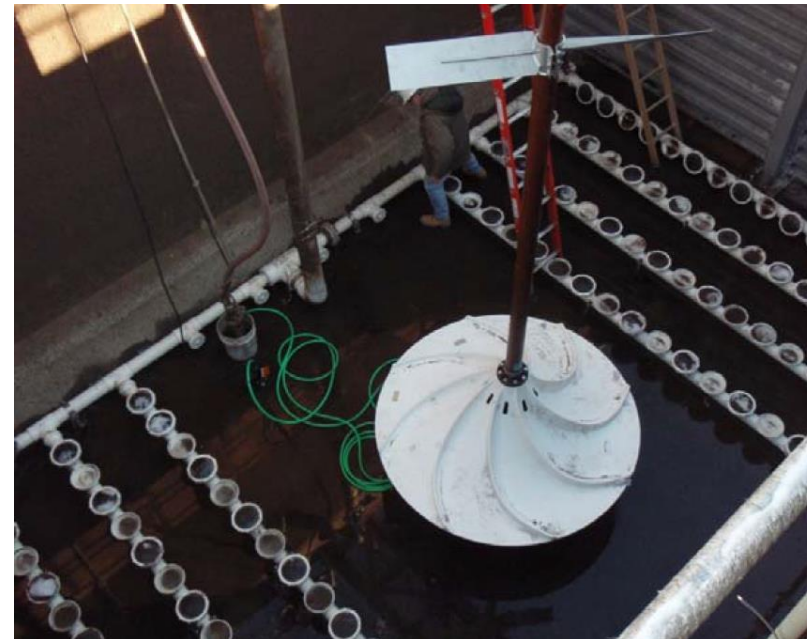

Bioreactors - IMLR Pumps

Design Criteria

Parameter	Value	Units
Type	Propeller	–
Manufacturer	Flygt	–
Quantity (per Bioreactor)	1 duty w/ shelf spare	#
Flow (min/avg/max)	12 / 17 / 24	MGD
Drive	VFD	–
Motor Size	5	hp

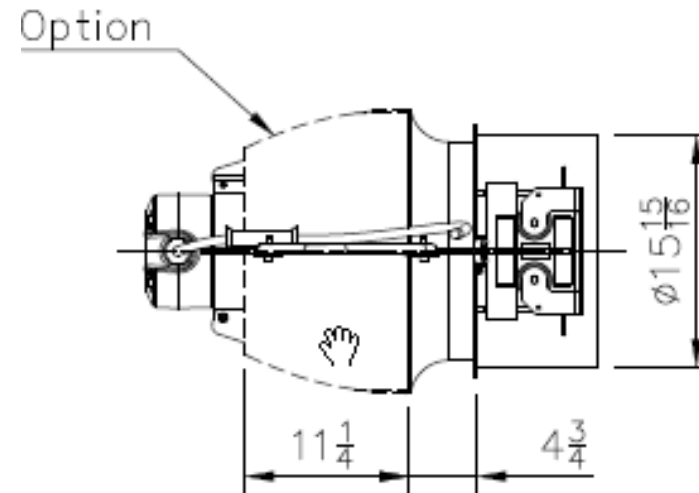
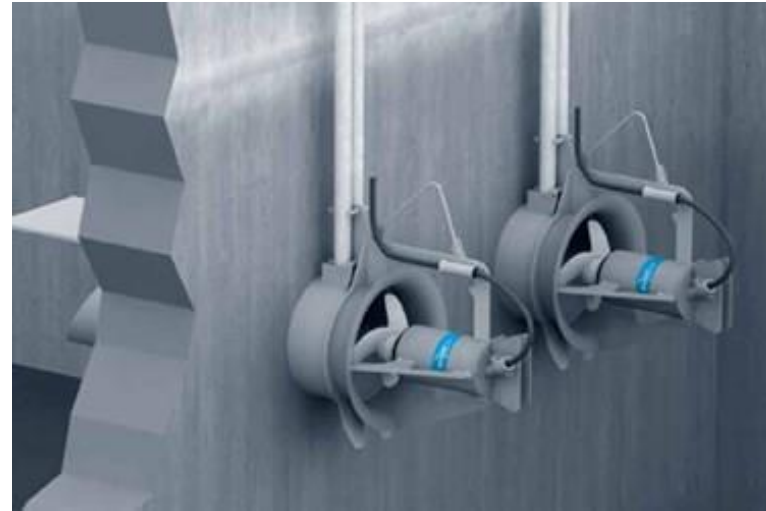

Bioreactors - O&M Considerations

- Goals for diffuser system - reliability, low maintenance and long-term performance
- Diffusers Comparison – Strip vs Retrievable vs Standard 9” Disc
 - Strip: Apprx 40% more energy efficient

Manufacturer	Standard System Material Cost	Retrievable System Material Cost	Aerostrip Aeration System Cost
SSI Aeration	\$360,000	\$1.8M	
Aquarius	\$355,000	\$1.5M - \$2M	
Sanitaire	\$490,000	\$1.55M	
Ovivo USA			\$1.57

Secondary Clarifiers - Key Operational Benefits/O&M Considerations

- Improved TB functionality with electric motor drive (move away from hydraulic drive system and festoon cables)
- SELs - Eliminates need for launder covers, minimizes algae growth, Reduced flow short circuiting
- Improved scum collection and transfer system
 - Simplified scum skimming mechanism – Mechanical blade skimmer with handwheel
 - Slotted pipe skimmer w/hand wheel operation
 - Replace scum drain lines
- Improved tank drain system
- Redundant rotary screen for operational flexibility

Secondary Clarifiers

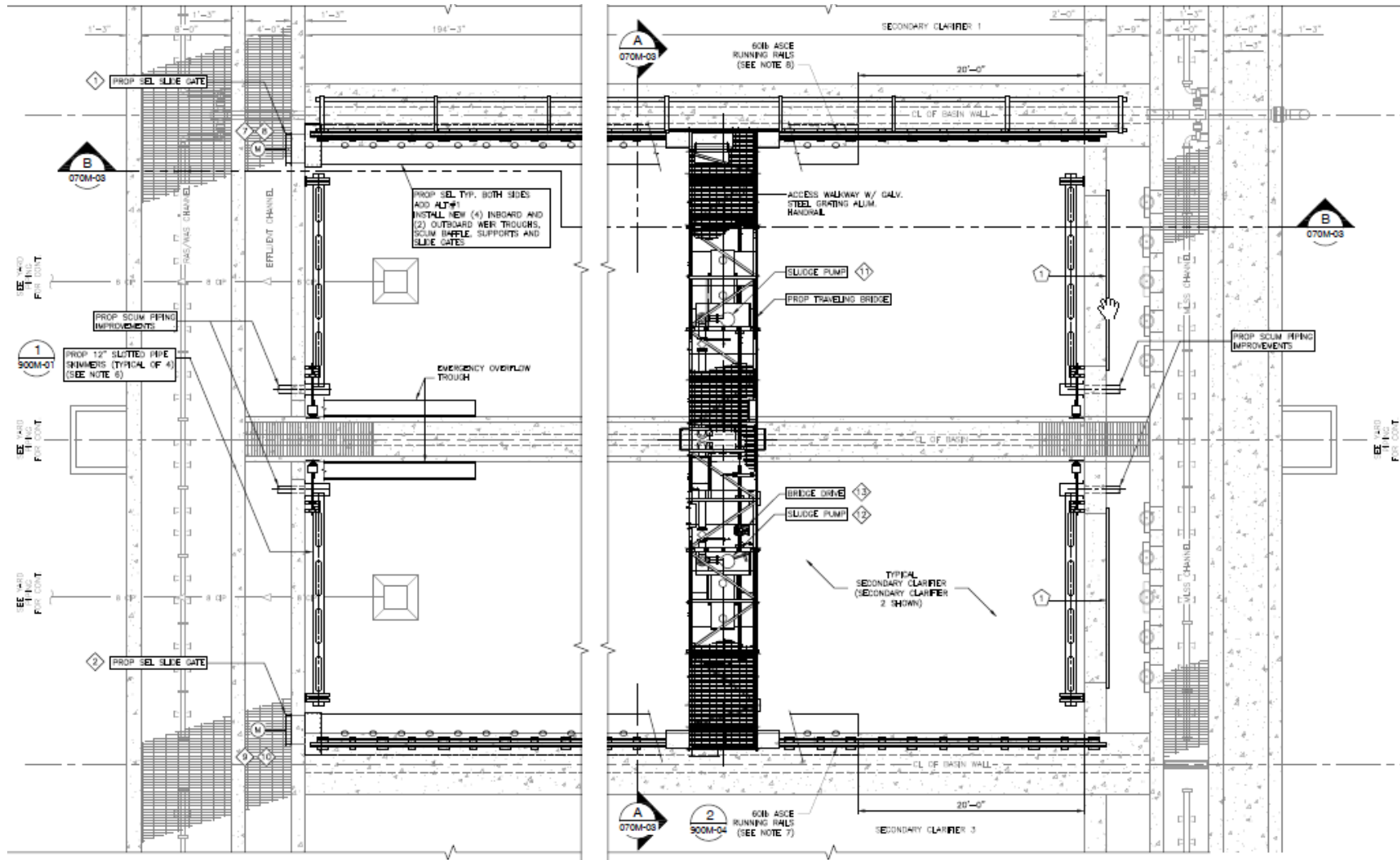

Secondary Clarifiers

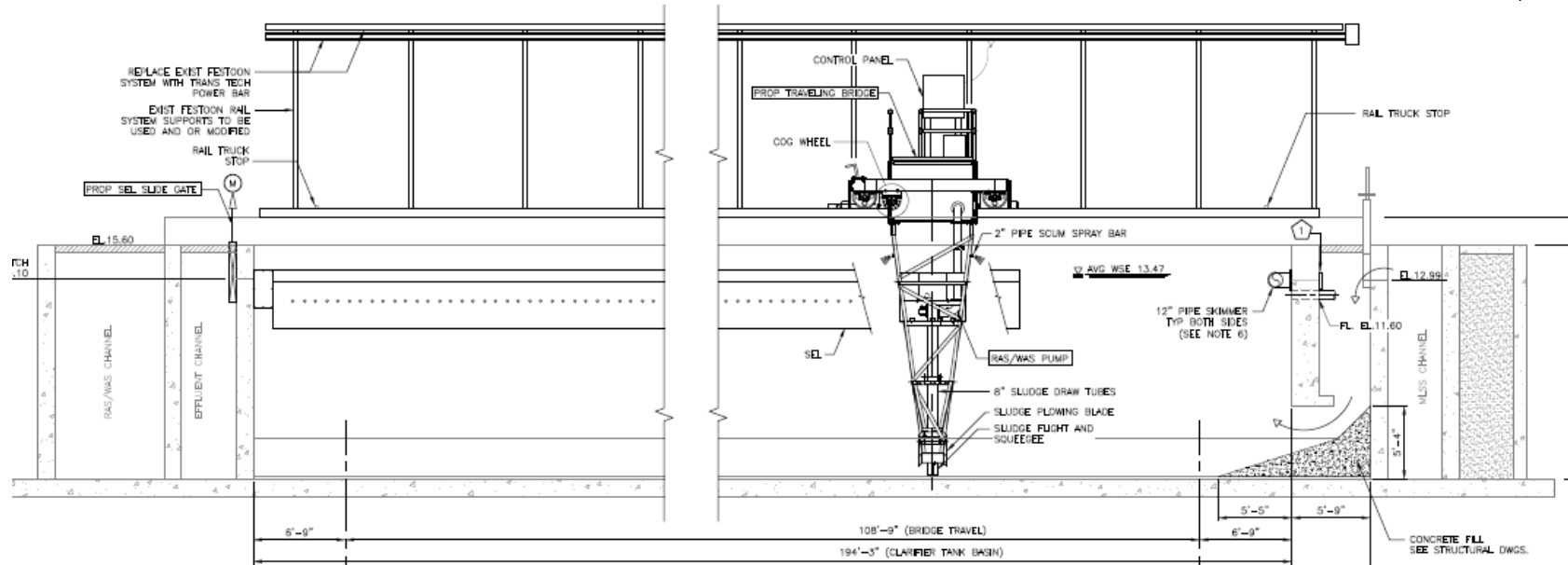
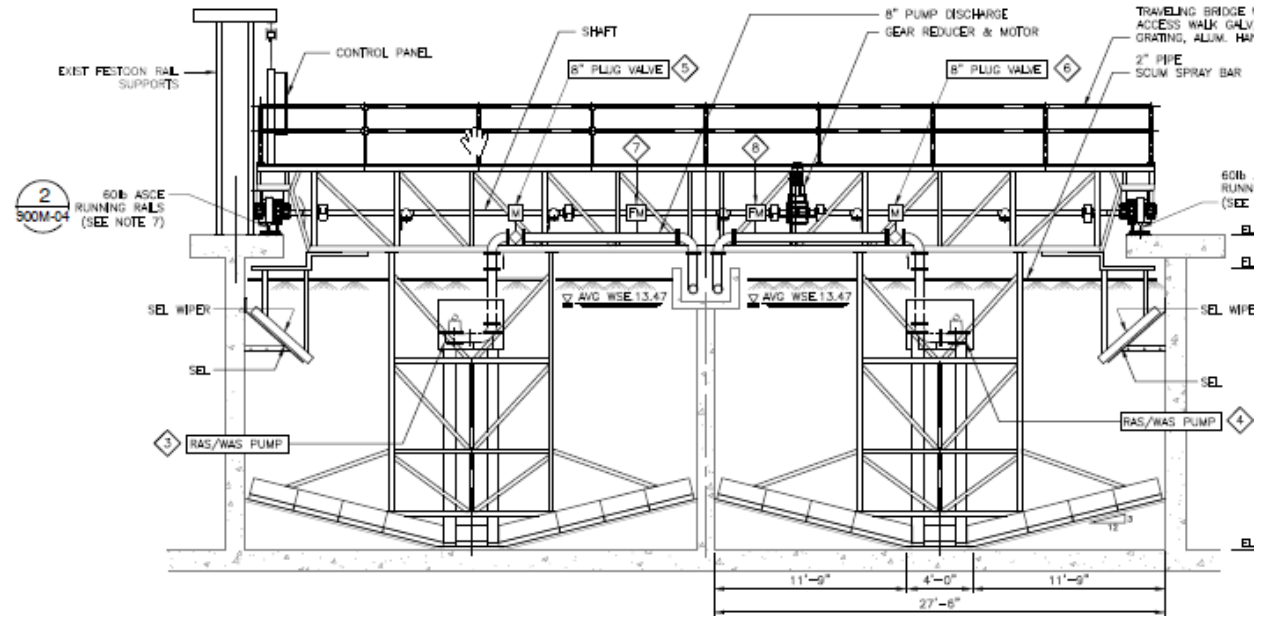

Scum Improvements

Key Operational Benefits/O&M Considerations

- Convert existing Aeration Basins to Bioreactors
- New 6 MGD Bioreactor
- Increase plant AAF treatment capacity to 18 MGD
- Step feed for wet weather events
- Fine bubble diffusers
- Hyperbolic mixers
- IMLR pumping

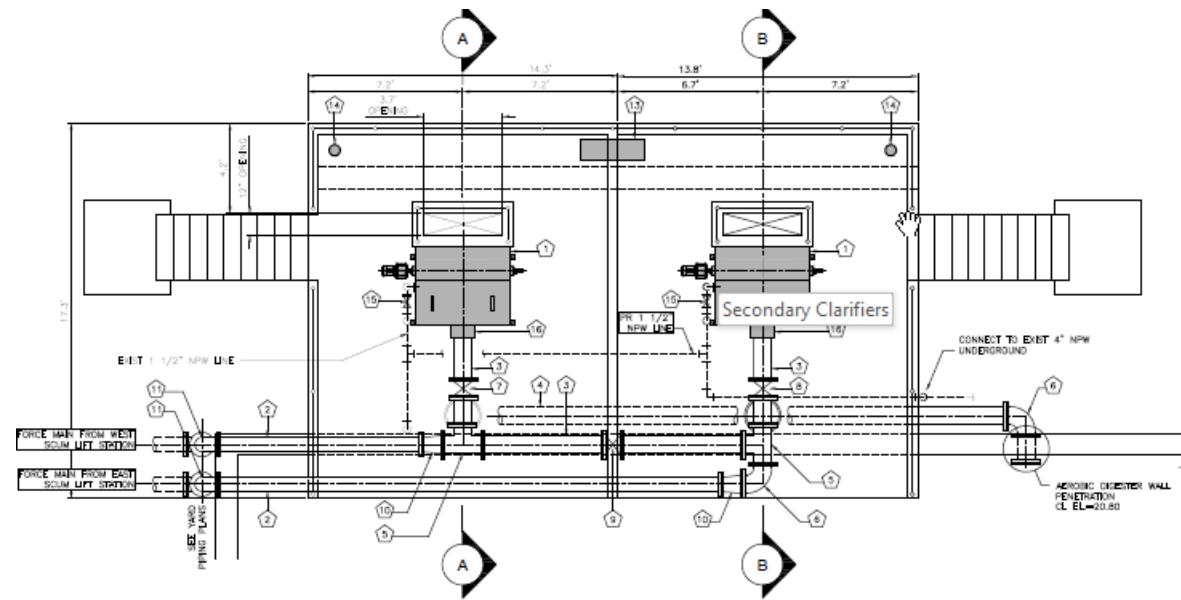

RAS Booster Station

O&M Considerations

- Convert existing Aeration Basins to Bioreactors
- New 6 MGD Bioreactor
- Increase plant AAF treatment capacity to 18 MGD
- Step feed for wet weather events
- Fine bubble diffusers
- Hyperbolic mixers
- IMLR pumping

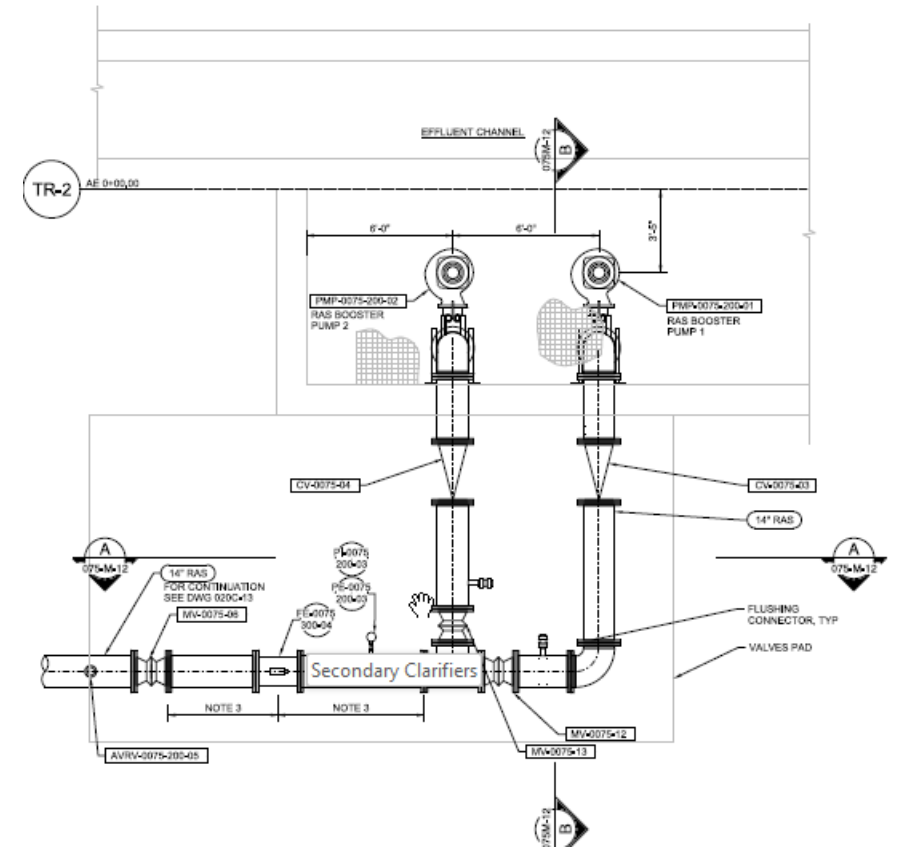
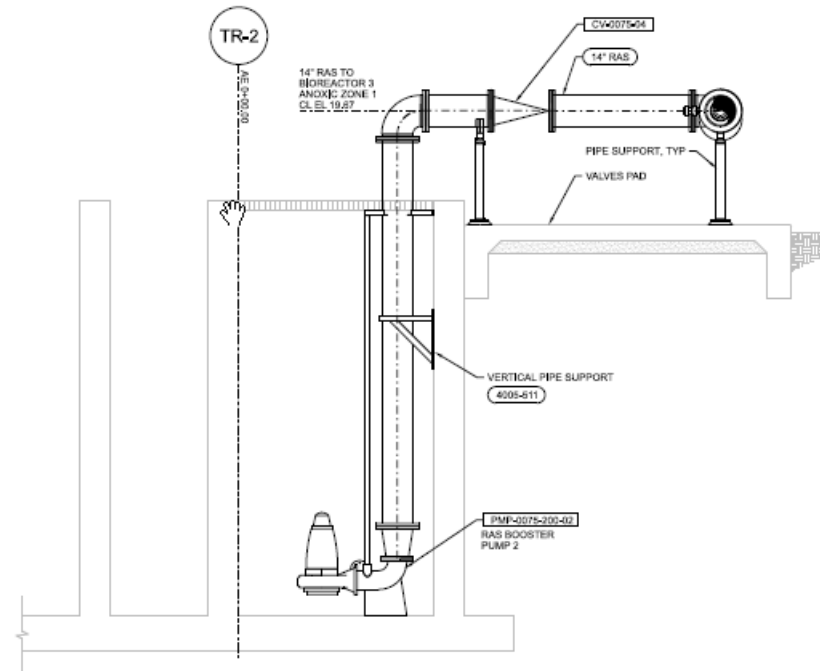

WAS Pump Station

Key Operational Benefits/O&M Considerations

- Convert existing Aeration Basins to Bioreactors
- New 6 MGD Bioreactor
- Increase plant AAF treatment capacity to 18 MGD
- Step feed for wet weather events
- Fine bubble diffusers
- Hyperbolic mixers
- IMLR pumping

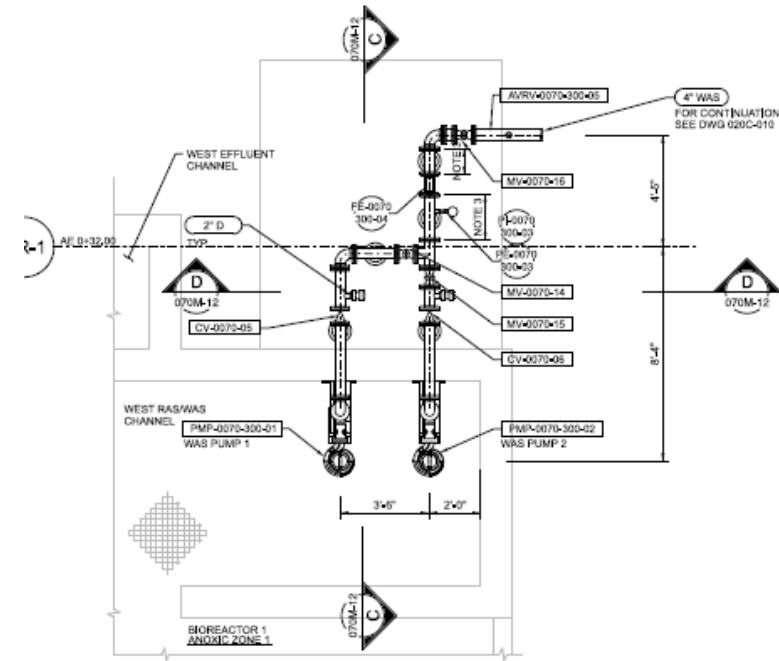
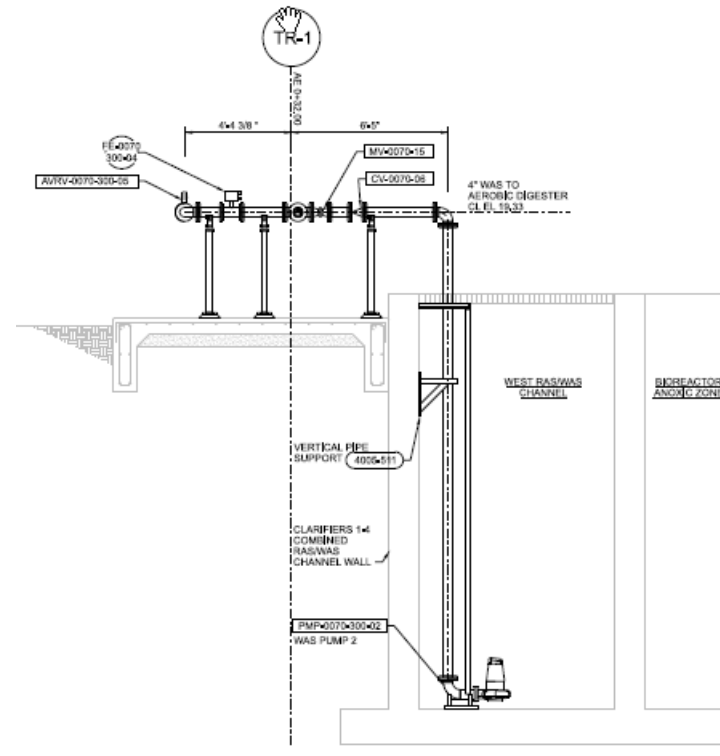

Chem Feed Systems

Facility Description

- Existing BPC system will be decommissioned
- FRP sodium hypochlorite (NaClO) storage tanks
- New NaClO feed pumps: 3 duty, 1 standby (per train)
- FRP sodium bisulfite (NaHSO₃) storage tanks
- New NaHSO₃ feed pumps: 3 duty, 1 standby (per train)
- Significant chemical demand reductions

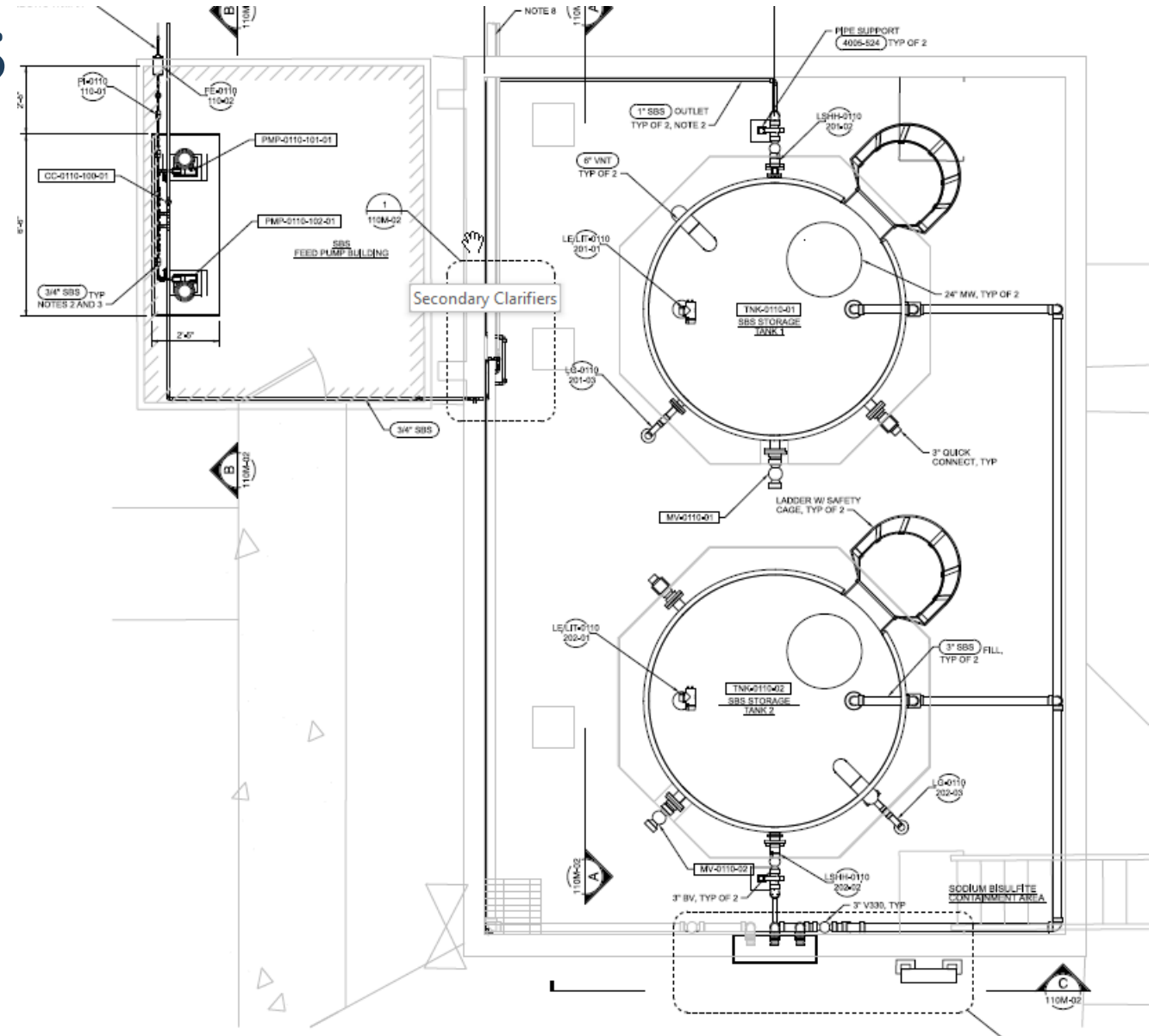

Solids Handling Improvements - Basis of Design

- 18 MGD -- Maximum Month:
 - WAS Flow: 520,000 gpd
 - Solids Loading: **33,700 lbs/d**
- 14 MGD -- Annual Average:
 - WAS Flow: **590,000 gpd**
 - Solids Loading: 26,400 lbs/d

Basis of Design – Thickening Equipment

Thickening Equipment		
Type	Volute Thickener	
Manufacturer	PWTech VT-302	
Design Thickened Solids Concentration	3	percent
Quantity of units (duty / standby)	2/1	
Hydraulic capacity per unit	300	gpm
Installed Capacity	900	gpm
Firm Capacity	600	gpm

Basis of Design – Dewatering Equipment

Dewatering Equipment		
Type	Volute Press	
Manufacturer	PWTech ES-354	
Quantity of units (duty / standby)	2/1	
Solids loading capacity per unit	2,100	dry lb / hr
Installed Capacity	6,300	dry lb / hr
Firm Capacity	4,200	dry lb / hr
Percent Solids Discharge (Minimum)	15	

Basis of Design – Dewatering Feed Design

Parameter	Value	Units
Configuration	ASH1 with dedicated pump for each dewatering volute press. AHS4 for emergency WAS storage.	
Aerated Sludge Holding Tank 1	670,000	gallons
Dewatering Feed Pumps	Submersible, Non-clog, Centrifugal	–
Manufacturer	<u>Flygt</u> , KSB	–
Number of Pumps (Duty + Standby)	2 + 1	#
Drive Type	VFD	–
Pump Capacity Range, each	150	gpm
Total Dynamic Head	20 - 50	psi
Estimated Motor Size, each	10	hp

Solids Handling - Area Overview

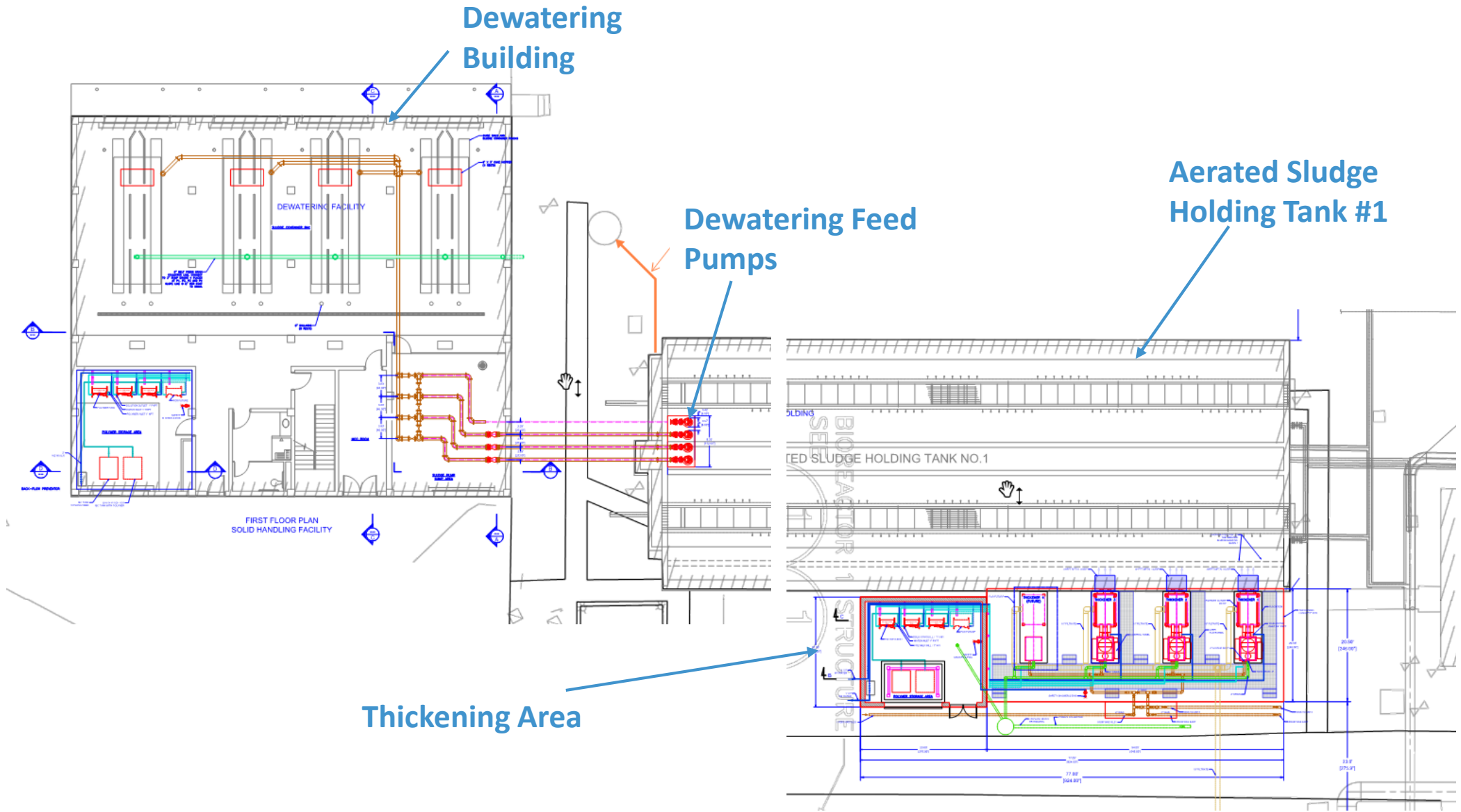

Aerated Sludge Holding Tank

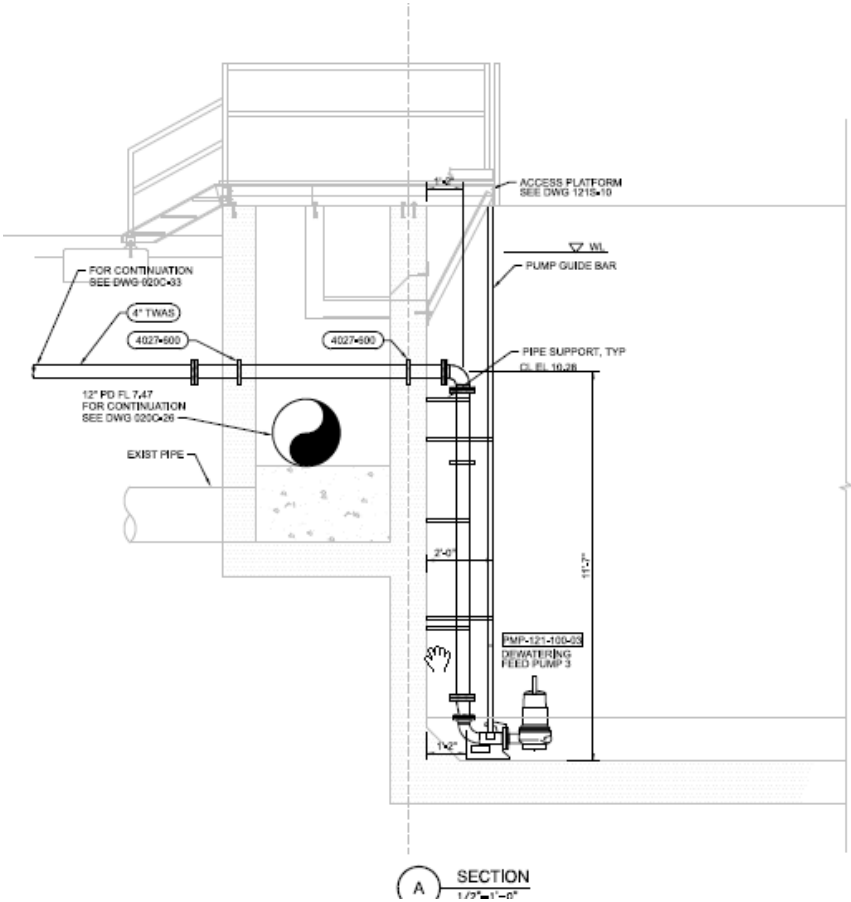
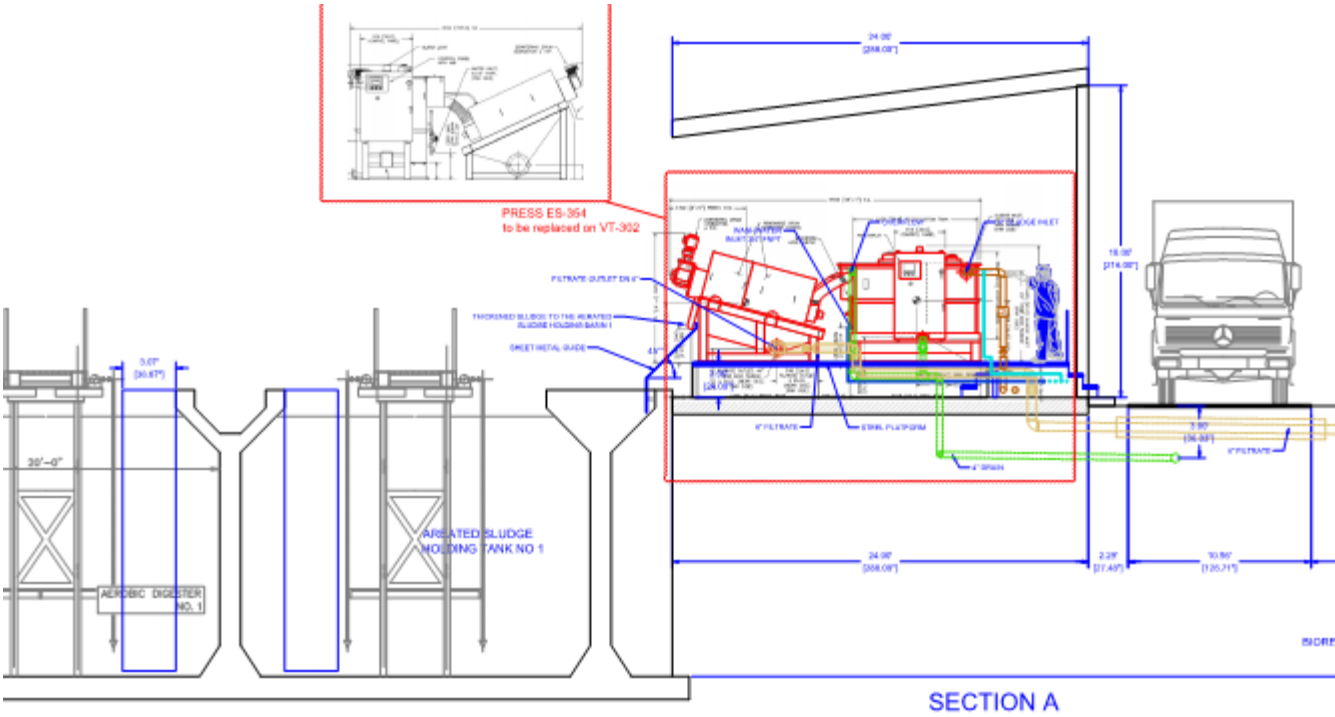

Aerated Sludge Holding Tank

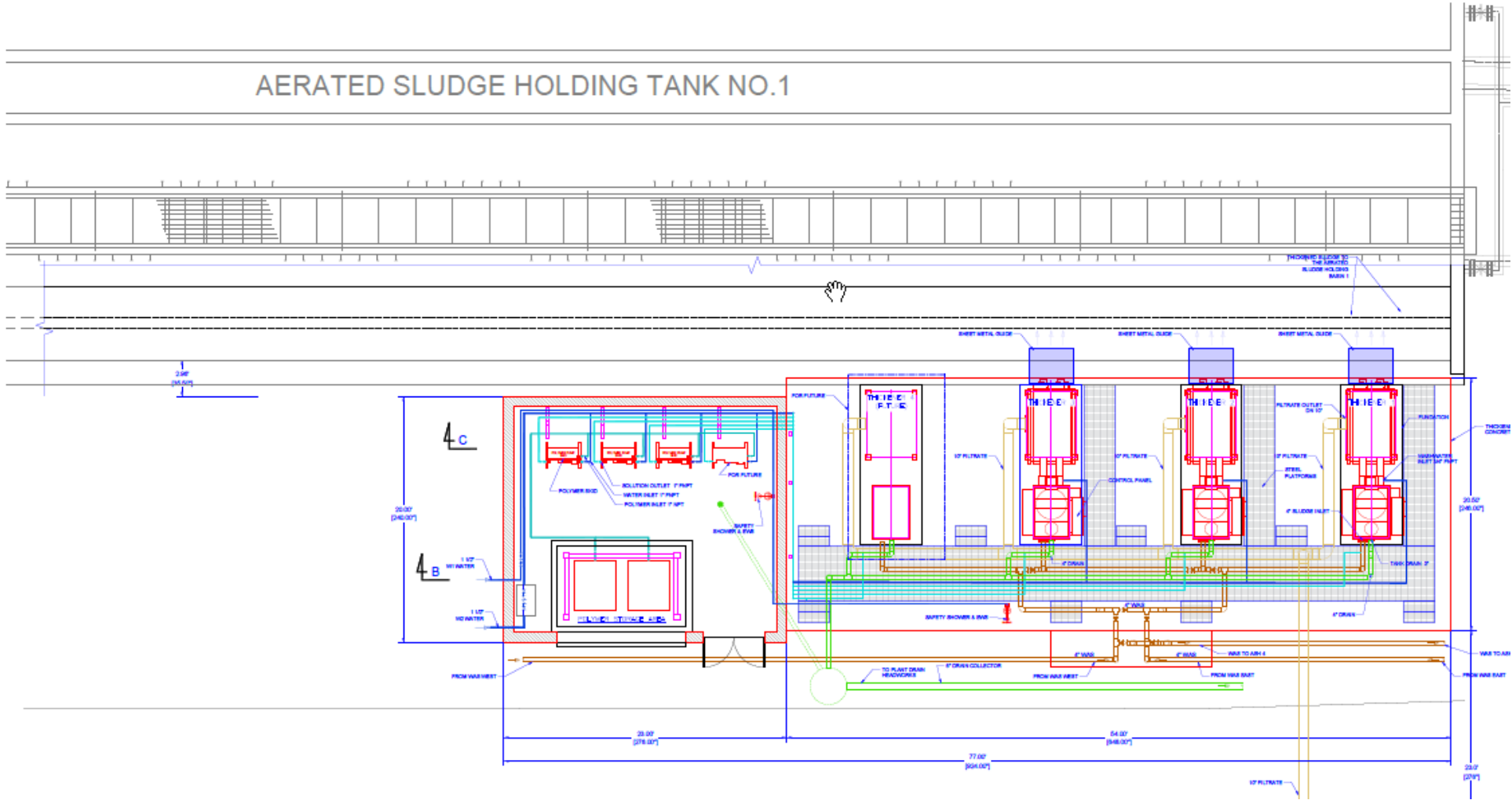

Solids Handling - O&M Considerations

- Operation flexibility in dewatering unit layout, TWAS pumps and discharge configuration eliminates “single point of failure” issue in system. If desired the use of any dewatering unit at any time can receive flows from any pump
- System design allows for emergency WAS storage at ASHT 4. A 4” overflow pipe/valve around WAS Pumps to ASHT 4 is included in design
- A bypass line around thickeners to allow dilution of biosolids (< 4% solids) in ASHT 1
- Potential to add more units to the system in the future
- Improved tank drain system
- FRP Grating to reduce corrosion
- Low operational complexity
 - Separate air system for BRs and sludge holding tanks allows for isolation of system when necessary
 - Add pressure sustaining valve on aeration header feeding ASHT 1 to avoid operating blowers at too low of a discharge pressure

Engineer's OPCC

Opinion of Probable Construction Cost	
Facility	Total Cost
Headworks Facility Stilling Weir Gate	\$145,000
Bioreactors 1 & 2	\$8,423,000
Bioreactors 3	\$11,251,000
New Blower Building and Aeration Piping	\$9,015,000
Clarifier 1-8 Traveling Bridge Equipment Replacement, Boosters & Pump Station	\$15,895,000
Scum System Improvements	\$3,831,000
Clarifier 1-8 - New Submerged Effluent Trough/Launders	\$3,244,000
Chlorine Contact Chamber 1-4 Equipment Replacement and Chem. Feed Improvements	\$4,550,000
Chlorine Contact Chamber 1-4 - New Effluent Weir Troughs	\$1,748,000
ECR Building and Electrical Improvements	\$4,875,000
Solids Dewatering and Sludge Thickening	\$9,940,000
Effluent JB Mech Improvements	\$15,000
Outfall Structure Improvements	\$35,000
Miscellaneous Improvements – Sitework, Paving, Utilities	\$6,035,000
CONSTRUCTION SUB TOTAL (2022 \$)	\$79,002,000
CONSTRUCTION SUB TOTAL (2024 \$)	\$87,100,000